



# IJEAST

INTERNATIONAL JOURNAL  
OF ENGINEERING APPLIED SCIENCE  
AND TECHNOLOGY



**VOLUME : 1    ISSUE : 6    Print / Issue Publication Date: 09-Oct-2016**



**ISSN : 2455-2143**



Indexed In



[WWW.IJEAST.COM](http://WWW.IJEAST.COM)

[editor@ijeast.com](mailto:editor@ijeast.com)



# MANUAL AND AUTOMATED OPERATION CONTROL ON USER DEMAND OF A MILLING MACHINE

Michail Papoutsidakis  
Dept. of Automation Engineering  
Piraeus University of Applied  
Sciences, Athens, Greece

Dimitrios Piromalis  
Dept. of Automation Engineering  
Piraeus University of Applied  
Sciences, Athens, Greece

Panagiotis Papageorgas  
Dept. of Electronics Engineering  
Piraeus University of Applied  
Sciences, Athens, Greece

**Abstract**— Computer Numeric Control (CNC) refers to a wide variety of machines which are controlled electronically and have many uses, including milling, drawing, extruding, cutting, and lathing. The application of computers to the control of the machine allows fine precision, reproducibility, and automation. For this project, a three-axis classical milling machine was in fact re-constructed to operate under commands of a modern microcontroller. The necessary Graphics User Interface (GUI) was designed all the way from the beginning following user friendly demands. The paper also presents a review of such machines and highlights the need of modern controllers attached to them for gaining a hands-on experience. This discuss is focused on communication between personal computer (PC), micro controller-ATMEGA168- and the stepper motors that move the machine on three dimensions. The objective to devise a computer controlled machine arose from increasing demand for flexibility and innovations with respect to edge quality, while at the same time the embedded system is designed to achieve cost effectiveness and also maintain reliability. This cleverly designed mechanical system along with the embedded system result in accuracy; it is a C programming language low budgeted application which is based on a micro controller that has not been used before for such task.

**Keywords**— 3 axis control, microcontrollers, interface design, code generation

## I. INTRODUCTION

### A. Short History

Numerical control (NC) is the automation of machine tools that are operated by precisely programmed commands encoded on a storage medium, as opposed to controlled manually by hand, wheels or levers, or mechanically automated by cams alone. The first NC machines were built in the 1940s and 1950s, based on existing tools that were modified with motors that moved the controls to follow points

fed into the system on punched tape. These early servomechanisms were rapidly augmented with analog and digital computers, creating the modern CNC machines that have revolutionized the machining processes. The CNC stands for Computer/Computerized Numerical Control. It is a process used in the manufacturing sector in which computers play an integral part of the control. On the surface, it may look like a normal PC controls the machines, but the computer's unique software and control console are what really sets the system apart for use in CNC machining, as in [1-4].

In modern CNC systems, end-to-end component design is highly automated using computer-aided design (CAD) and computer-aided manufacturing (CAM) programs. The programs produce a computer file that is interpreted to extract the commands needed to operate a particular machine by a post processor, and then loaded into the CNC machines for production. Since any particular component might require the use of a number of different tools – drills, saws, etc., modern machines often combine multiple tools into a single "cell". In other installations, a number of different machines are used with an external controller and human or robotic operators that move the component from machine to machine. In either case, the series of steps needed to produce any part is highly automated and produces a part that closely matches the original CAD design, like [5-8].

### B. Usage

CNC machines are widely used nowadays for industrial and personal purpose. They are useful for any process that can be described as a series of movements and operations. These include laser cutting, welding, friction stir welding, ultrasonic welding, flame and plasma cutting, bending, spinning, hole-punching, pinning, gluing, fabric cutting, sewing, tape and fiber placement, routing, picking and placing, and sawing. But, they are primarily used for two ways to process materials: lathing and milling. Nearly every kind of material can be handled with ease.

Mills: CNC mills use computer controls to cut different materials. They are able to translate programs consisting of specific numbers and letters to move the spindle (or workpiece) to various locations and depths. Many use G-code,

which is a standardized programming language that many CNC machines understand, while others use proprietary languages created by their manufacturers. These proprietary languages while often simpler than G-code are not transferable to other machines. CNC mills have many functions including face milling, shoulder milling, tapping, drilling and some even offer turning. A standard milling machine consists of 3 axes (X, Y, Z) moving in three dimensions, length, width and depth. Today, CNC mills can have 4 to 6 axes. This way every possible move in the Cartesian coordinate system can be performed. Except the standard system, it is possible to extend the capabilities of the machine by adding extra axes. At the moment, one can use up to 9 axes.

**Lathes:** Lathes are machines that cut workpieces while they are rotated. CNC lathes are able to make fast, precision cuts, generally using index able tools and drills. They are particularly effective for complicated programs to make parts that would be more difficult to make on manual lathes. CNC lathes have similar control specifications to CNC mills and can often read G-code as well as the manufacturer's proprietary programming language. CNC lathes generally have two axes (X and Z), but newer models have more axes allowing for more advanced jobs to be machined.

### C. Motion

Motion is controlled along multiple axes, normally at least two (X and Y), and a tool spindle that moves in the Z (depth). The position of the tool is driven by direct-drive stepper motor or servo motors in order to provide highly accurate movements, or in older designs, motors through a series of step down gears. Open-loop control works as long as the forces are kept small enough and speeds are not too great. On commercial metalworking machines, closed loop controls are standard and required in order to provide the accuracy, speed, and repeatability demanded.

### D. Benefits

The benefits of using CNC Machining is the ability of having multiple materials processed in a short period of time with high precision and the procedure can be repeated in exactly the same manner over and over again. In addition, the code is highly adaptable and the user is able to perform any change desired. Latest software development offers the ability to elaborate a lot easier and even faster than before, by simply scanning a given picture instead of writing code for it. All these would be almost impossible to achieve with manual machining.

The rest of the paper is organized as follows. Proposed embedding and extraction algorithms are explained in section II. Experimental results are presented in section III. Concluding remarks are given in section IV.

## II. SYSTEM DESCRIPTION

The system under investigation consists of a MAXNC 15 closed-loop milling machine which is equipped with 3 stepper

motors (POWERMAX P22NRXC-LDN-NS-00) to move the 3 axes, (plus 1 motor to attach if necessary) you wish, an AC-DC series motor used for spindle (110 Volts, 2.9 Amps), a 12.6VDC power supply, a controller and a motor driver unit. The spindle motor and the cutting tool are attached to the Z-axis threaded screw. The system in the laboratory environment is provided below in figure 1.

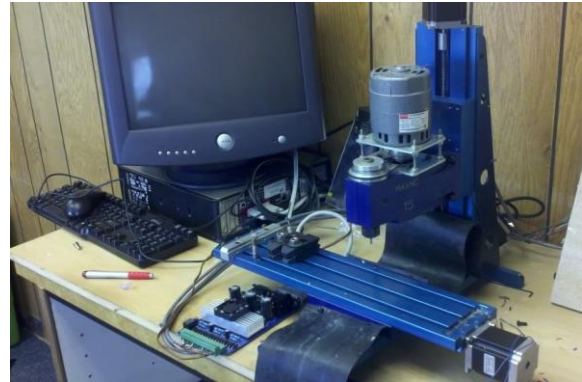

Figure1. The system main layout

The microcontroller which was selected to do the task was the ATmega168 chip attached on an embedded board by the manufacturer. This low cost and easy to program installation, allows engineers to experiment with safety and high standards of repeatability and accuracy. It comes to the market under the ARDUINO umbrella, the so called "ARDUINO NANO", a fact that ensures ready documentation and guidelines, low cost and easily purchase. For this specific task and the equipment described earlier in this chapter the Arduino Nano has not been applied yet in order to drive a milling machine of this kind, as in [9-11].

### A. Short History

The first Arduino was introduced in 2005. It was aimed to be an inexpensive and easy way for anyone to make interactive projects that can sense and control objects in the physical world. Common examples of such devices intended for beginner hobbyists include simple robots, thermostats, and motion detectors. It is an open-source electronics platform based on easy-to-use hardware and software. Arduino was born at the Ivrea Interaction Design Institute as an easy tool for fast prototyping, aimed at students without a background in electronics and programming. As soon as it reached a wider community, the Arduino board started changing to adapt to new needs and challenges, differentiating its offer from simple 8-bit boards to products for IoT applications, wearable, 3D printing, and embedded environments. All Arduino boards are completely open-source, empowering users to build them independently and eventually adapt them to their particular needs. The software, too, is open-source, and it is growing through the contributions of users worldwide. In addition, it is

backed up by a growing online community, which is useful for debugging.

### B. Implementation

The project is based on microcontroller board designs, manufactured by several vendors, using various microcontrollers. These systems provide sets of digital and analog I/O pins that can be interfaced to various expansion boards ("shields") and other circuits. The boards feature serial communications interfaces, including USB on some models, for loading programs from personal computers. For programming the microcontrollers, the Arduino project provides an integrated development environment (IDE) based on the Processing project, which includes support for the C and C++ programming languages, as in [12-13].

### C. Integration

The NANO is the best board to get started with electronics and coding. It is the most robust board you can start playing with. Also, it is one of the most used and documented board of the whole Arduino & Genuino family. In addition to all the features of the previous board, the NANO now uses an ATmega168 instead of the FTDI chip. This allows for faster transfer rates, no drivers needed for Linux or Mac, and the ability to have the Nano show up as a keyboard, mouse, joystick, etc. It contains everything needed to support the microcontroller and you can simply connect it to a computer with a USB cable or power it with a AC-to-DC adapter or battery to get started.

### D. Earlier Work

**Alarm System:** This simple alarm system uses a motion sensor to detect movement and emit a high pitched tone, as well as a visual display consisting of flashing LED lights. The project itself will introduce you to a couple of add-ons, as well as the nuances of using New Ping, which is an Arduino library used to help you monitor and test your sonar distance sensor. While it's not exactly whole home protection, it does offer a perfect solution to protect small spaces, such as bedrooms or your snack drawer, from those creeping roommates of yours.

**The Traffic Light Controller:** This super simple project is a great introduction to Arduino programming. The traffic light controller uses a red, yellow, and green LED to re-create a traffic light on your breadboard, and give you the opportunity to hack the code in order to adjust the output, timing or even the sequence itself.

**Sorting Machine:** This project demonstrates how simple is to build intelligent machines with an Arduino microcontroller. This sorting machine is designed to separate colored candies by colors. It can handle up to 500 grams of colored candies at a speed of 80 pieces per minute.

**Arduino Digital Power Switch:** It is a "silent" digital electric switch circuit built around the exemplary  $\mu\text{C}$  Arduino (NANO) and a homemade solid-state relay (SSR). The finished system, which operates in low voltage dc catered by

the usb port, can be used to toggle (switch on/off) a mains powered device through your desktop/laptop computer.

**Remote controlled car and TV remote:** This project is a four-wheel robot car controlled remote via TV remote. The project includes beside Arduino NANO, two DC motors, IR receiver, an L293D motor driver IC, batteries, wires, a simple chassis, and wheels.

In figure 2, a photo of the microcontroller board is provided.



Figure2. The  $\mu\text{Controller}$  board

In order for a reader to understand the placement of the system components and their architecture, including the CNC machine, the above discussed microcontroller and all peripherals, a block diagram schematics is provided below in figure 3.

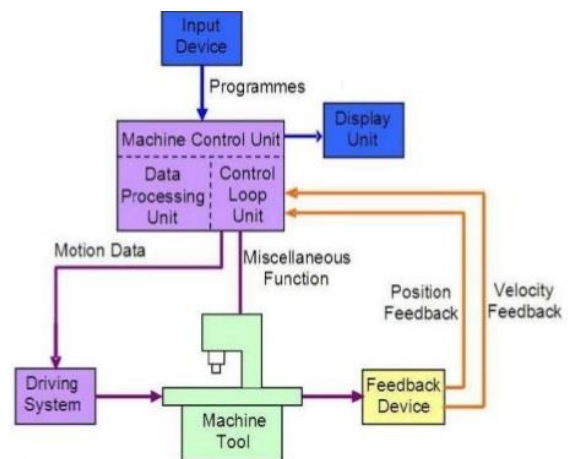

Figure3. The system schematic layout

In the above figure it can be noticed the existence of a block component referred as "Driving System". This is between the microcontroller and the stepper motors of the CNC machines and it actually amplifies the DC current sent from the microcontroller to the motors as the control signal. The output of the controller need this kind of amplification depending on

the motors requirements as well as converts the digital signals to proper pulses for the motors to operate. So, to drive the stepper motors, the CNC 3 Axis Stepper Controller V4.0 shield was chosen, which drives one bipolar stepper motor at up to 2 A output current per coil. The connections and the required circuitry is the following.

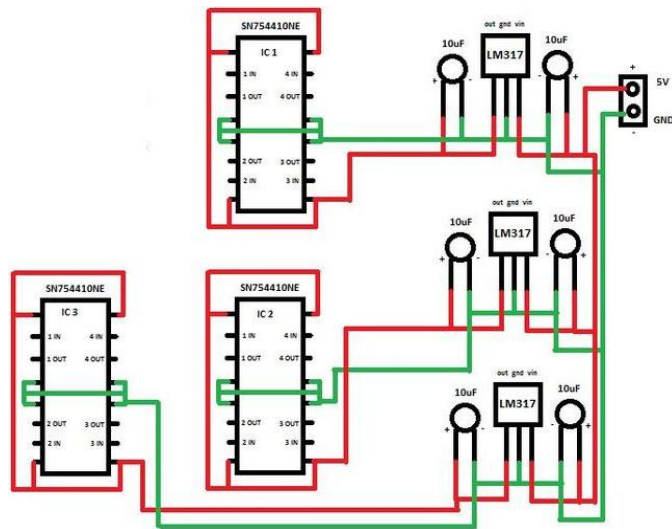

Figure4. CNC 3 Axis Stepper Controller V4.0 circuitry

There are many reasons for selecting this driver shield, summarized as follows:

- Low Rds (on) outputs
- Automatic current decay mode detection/selection
- Mixed and slow current decay modes
- Synchronous rectification for low power dissipation
- Internal UVLO
- Crossover-current protection
- 3.3 and 5 V compatible logic supply
- Thermal shutdown circuitry
- Short-to-ground protection
- Shorted load protection
- Five selectable step modes

A reasonable question arose from the use of this electronic board, since there are 3 stepper motors to drive (each one to move the machine in one axis respectively). The answer is that in this project, 3 axis controllers were used and in an attempt to escape wirings and connections for each one of them with the microcontroller, a specific board was picked up from the market to cover the connectivity task. It is illustrated in figure 5, and it must be stated that it is fully compatible with the microcontroller board (placed at the top of the board) in a ultimate way to make the dimensions of the electronics of the project even smaller.

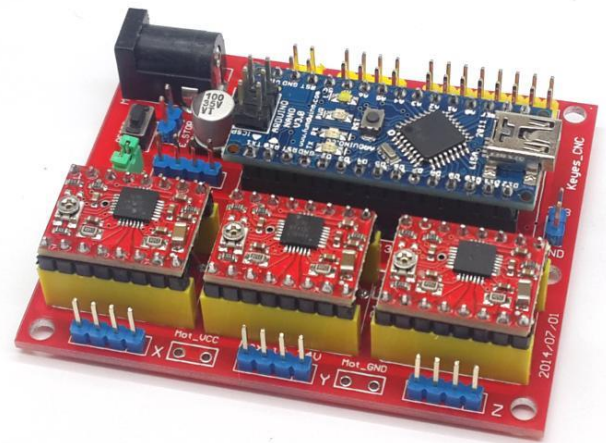

Figure5. CNC 3 Axis Stepper Controller V4.0

To power the motors and the controller some components that already existed were used, along with an emergency button, added for safety reasons, some diodes and capacitors, as: 110V/12V 2A Transformer, diodes 80V, 2A and electrolytic capacitors 2200mF/25V. All electronics peripherals and external power supply connections for driving the motors were properly installed in order to secure safety and reliability.

### III. USER MACHINE INTERFACE

In computing, an interface is a shared boundary across with two separate components of computer system exchange information. The exchange can be between software, computer hardware, peripheral devices, humans and combinations of these. Some computer hardware devices such as a touchscreen can both send and receive data through the interface, while others such as a mouse, microphone or joystick are one way only. For example, the LabVIEW Interface for the Arduino microcontroller allows developers to acquire data from the Arduino microcontroller and process it in the LabVIEW Graphical Programming environment, like [14-15]. It can be categorized as follows:

- **Hardware interface:** A hardware interface is described by the mechanical, electrical and logical signals at the interface and the protocol for sequencing them.
- **Software interface:** A software interface may refer to a wide range of different types of interface at different "levels": an operating system may interface with pieces of hardware. Applications or programs running on the operating system may need to interact via streams, and in object oriented programs, objects within an application may need to interact via methods.
- **User interface:** A user interface is a point of interaction between a computer and humans. It includes any number of modalities of interaction, such as graphics, sound, position and movement

where data is transferred between the user and the computer system.

In this research project, the CNC milling machine is programmed in the so-called well known G-code language. This protocol is the most usually used for such devices worldwide and in its format it looks like assembly programming. There are a few commands available to drive the machine and the user can get familiarized with it easily and quickly. In general, G-code is an industry standard for a machine control instruction set, specified in several international standards including RS274D and ISO 6983. G-code files are ASCII text files, consisting of a sequence of command codes. Each command code is a single alphabetical character followed by numeric parameters. While standards exist, many proprietary extensions and modifications are introduced by manufacturers for their specific machines. The G-code produced by the G-code tools conversion software conforms to the standard expected by Enhanced Machine Controller Stepper motors are more precise for a task like routing for CNC machines, which made them a desirable choice for such projects. Unlike DC motors, the stepper motors are brushless, synchronous electric motors that can divide a full rotation into a large number of steps. This allows the user for precise controlling without any feedback system. Stepper motors are constant power devices, as speed increases, the torque decreases. Stepper motors come in different types:

uni-polar which are easy to drive but have low torque and speed, and bipolar which are hard to drive but have high torque and high speed. An example of G-code programming window can be seen in figure 6.

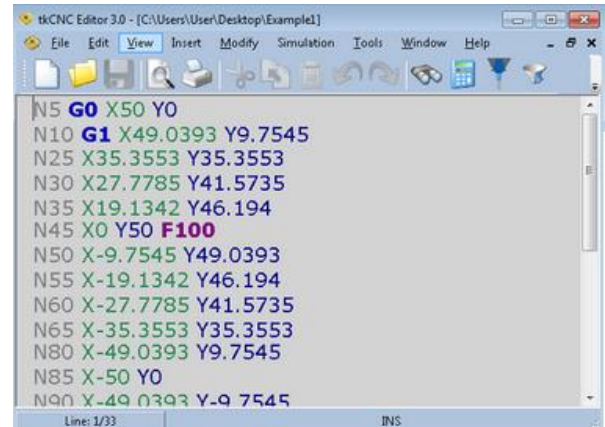

Figure 6. Typical G-code window

At this stage, it was decided to illustrate the custom made interfaces (1 in manual mode and 1 in auto mode) that was designed for this project and therefore the next page is dedicated to that. All explanations follow in the rest of the paper.

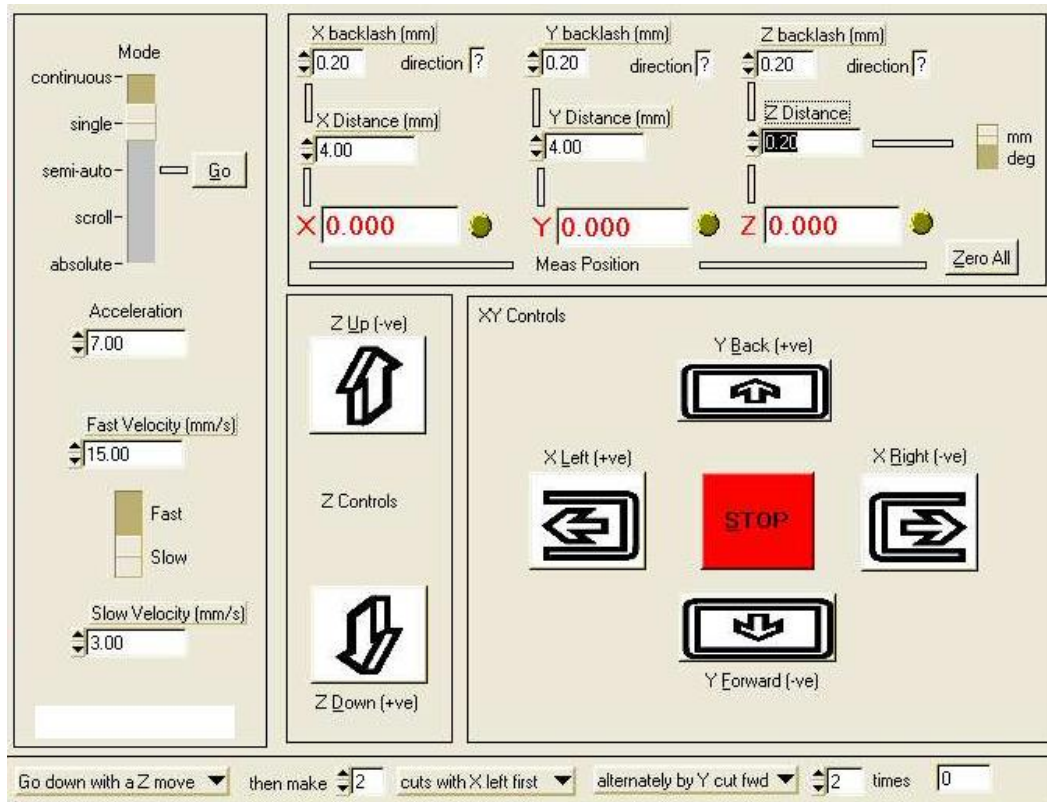

Figure 7. The interface of the system in the manual operation

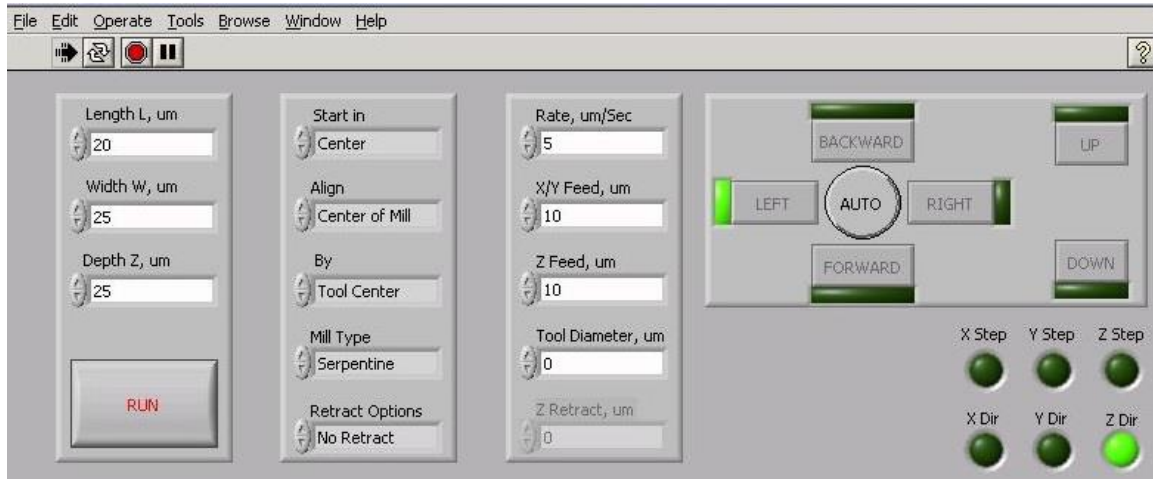

Figure 8. The interface of the system in the automated operation

The innovation of this project beyond the fact of the co-operation of the Arduino Nano with the MAXNC milling machine, is that there is a dual mode of operation. This means in fact that the interface is different in case the system operates in manual or auto mode. In the manual mode all functions are given by the user via the computer keyboard or mouse. The tuning of parameters like velocity and acceleration in all 3 axis as well as the milling tool guidance, are given as commands manually in the interface buttons respectively, as figure 7 indicates. On the contrary, in case the user demands an automated operation of the milling process, which does not require his presence, the user selects another interface for communication with the machine. All G-code programming is downloaded to the machine via the Arduino microcontroller automatically and although the interface panel (figure 8) includes buttons for forward, backward, left and right navigation, this functions take place automatically according to the G-code program. The user watches the operation of the machine via the interface panel since for every movement there is a respective LED that flashes for each motion. This allows the user to be more flexible in terms of operating the machine because he can chose a fast way of operation (manual) if the application is very simple and not repeatable and on the other side he can chose the automated operation in case the application requires accuracy, long term operation and speed.

#### IV. CONCLUSION

In this project, the design of a CNC milling machine that performed well enough to meet the initial goals for precision, cost, ease of use and repeatability. This work has provided the authors with an opportunity to build an innovating restructured version of CNC machine. The hands-on mechanical work has been a learning task for the research team and the process has been an expertise curve as many aspects of CNC machine

design and metalworking have been explored. All of these factors contributed to a successful project which began in the planning phase and ended with a deliverable product which meets the expectations and hypothesis that was set all the way from the beginning.

As a functional CNC machine has been completed, the author hopes that the machine will see further use, hopefully becoming a valuable addition to the manufacturing equipment available at the robotics and intelligent systems research group. The authors further hope that the members of the research group feel free to further modify the built CNC milling machine if this leads to further improvements of the machine.

#### V. REFERENCE

- [1] Zeid, Ibrahim (2005). *Mastering CAD/CAM*. Boston, MA: McGraw-Hill Higher Education
- [2] Stroud, Ian and Hildegard Nagy (2011) "Solid modelling and CAD systems: how to survive a CAD system", London: Springer. DOI: 10.1007/978-0-85729-259-9
- [3] Nirav A., "Two Legged Robot Design, Simulation and Realization Patel", Proceedings of the 4th International Conference on Autonomous Robots and Agents, Feb 10-12, 2009, Wellington, New Zealand.
- [4] E. Hristoforou and H. Chiriac, Glass Covered Fe-Rich Amorphous Wires Used as Magnetostrictive Delay Lines, *Sensors & Actuators A*, 81, p. 158 – 161, 2000.
- [5] Smith, M.H., Annaswamy, A.M., Slocum, A.H., "Adaptive Control Strategies for a Precision Machine Tool Axis", *Precision Engineering*, Vol. 17, No. 3, 1995, pp. 192- 206. Berkeley, CA: Apress. DOI: 10.1007/978-1-4302-2490-7.



- [6] Lorenz R.D, Lipo T. A., Novotny D. W.; “Motion control with induction motors”, Proceedings of the IEEE, Vol. 82, no.8, August 1994
- [7] A. Christopoulos, E. Hristoforou, I. Koulalis, G. Tsamasphyros, G., Inductive strain sensing using magnetostrictive wires embedded in carbon fibre laminates, *Smart Materials and Structures*, 23 (8), 085035, 2014
- [8] Francesco Calabrese, Giovanni Elentano, “Design and realization of STEP-NC compliant CNC embedded Controller”
- [9] M. Pletea, H. Chiriac, E. Hristoforou, M. Neagu, Miniaturized Magnetostrictive Delay Line Arrangement Using Multilayer-Like Structure, *Sensors & Actuators A*, 92, p. 115-118, 2001.
- [10] Hongen Wu, Chengrui Zhang, Guili Li and Baoren Wang, “Windows XP Embedded based Open Architecture Computer Numerical Control System”
- [11] Mota, Catarina (n.d.). “The rise of personal fabrication.” In: Proceedings of the 8th ACM conference on creativity and cognition. ACM, pp. 279–288
- [12] Petter, J.; McCarthy, J.; Pollak, P.; Smith, C.C.; “Survey of DC current measurement techniques for high current precision power supplies”, Nuclear Science Symposium and Medical Imaging Conference, 1991., Conference Record of the 1991 IEEE, 2-9Nov.1991; Pages:961 - 967 vol.2
- [13] Singhose W. E., Searing W. P. and Singer N. C.; "Improving repeatability of coordinate measuring machines with shaped command signals" *Precision Engineering*, Volume 18, Issues 2-3, April-May 1996, Pages 138-146
- [14] Hokanson, Taylor and Chris Reilly (2011). “DIYLILCNC: open source plans for a low-cost desktop CNC mill.” In: ACM SIGGRAPH 2011 studio talks. ACM, p. 8.
- [15] G.S.E. Antipas, E. Statharas, P. Tserotas, N. Papadopoulos and E. Hristoforou, Experimental and first principles’ characterization of functionalized magnetic nanoparticles, *ChemPhysChem*, 14 (9) , pp. 1934-1942, 2013

# IJEAST

INTERNATIONAL JOURNAL  
OF ENGINEERING APPLIED SCIENCE  
AND TECHNOLOGY

## ABOUT IJEAST

International Journal of Engineering Applied Science and Technology (IJEAST) is a peer-reviewed, open access journal that publishes high-quality research papers in the field of Engineering, Applied Science and Technology.

IJEAST aims to provide a platform for researchers, academicians, and professionals to share their innovative ideas, research findings, and practical experiences with the global scientific community.

## FOCUS AREAS

- Engineering
- Applied Science
- Technology
- Innovation & Development
- Interdisciplinary Studies



### PEER REVIEWED

All submissions are rigorously peer reviewed to ensure quality.



### OPEN ACCESS

Free and unrestricted access to research for all.



### GLOBAL REACH

Connecting researchers and professionals worldwide.



### TIMELY PUBLICATION

We ensure a swift and efficient publication process.



For more information, visit our website

[www.ijeast.com](http://www.ijeast.com)



INTERNATIONAL JOURNAL  
OF ENGINEERING APPLIED SCIENCE  
AND TECHNOLOGY

✉ [editor@ijeast.com](mailto:editor@ijeast.com)

🌐 [www.ijeast.com](http://www.ijeast.com)

📍 India



2455-2143