



# IJEAST

INTERNATIONAL JOURNAL  
OF ENGINEERING APPLIED SCIENCE  
AND TECHNOLOGY



**VOLUME : 4    ISSUE : 10    Print / Issue Publication Date: 09-Apr-2020**



**ISSN : 2455-2143**



**DOI : 10.33564/IJEAST.2020.v04i10.039**

Indexed In



[WWW.IJEAST.COM](http://WWW.IJEAST.COM)

[editor@ijeast.com](mailto:editor@ijeast.com)



# SOLAR CELL EFFICIENCY OPTIMIZATION USING SIMULATION PARAMETER

Swati Pandey  
Faculty SIRT,  
Bhopal, M.P., India

**Abstract** –The earth receives more energy from the sun in just one hour than the world's population uses in whole year. The total solar energy flux intercepted by the earth on any particular day is  $4.2 \times 10^{18}$  watt-hours or  $1.5 \times 10^{22}$  joules. In fact the world's total energy consumption of all forms in year 2000 was  $4.24 \times 10^{20}$  joules. In the year 2016-17 the gross electricity consumption increases to 1,122Kwh per capita. India rank in production of electricity is third while in consumption is ranked fourth. In this paper charging and discharging of solar cells by using PV cell is reviewed.

**Keywords** solar panel, PV cell, charge controller, battery

## I. INTRODUCTION

A solar cell is a device which converts the solar energy into electricity by the photo voltaic effect. It is a form of photoelectric cell, defined as a device whose electrical characteristics, such as current, voltage, or resistance, vary when exposed to light. Solar cells are the building blocks of photovoltaic modules, known as solar panels. simple circuit to charge a rechargeable lead acid battery (12V,1.3AH) from the solar panel. The solar charger has regulation of current, voltage and also has over voltage cut off services. This circuit may also be used to charge the lead acid battery at constant voltage because output voltage is variable. <sup>[1]</sup>

The working of solar cell depends on following conditions:

1. The absorption of light, generating either electron hole pairs or exactions.
2. The separation of charge carriers of opposite types.
3. The separate extraction of those carriers to an external circuit.

## II. LITERATURE REVIEW

1. D. Ganesh, S. Moorthi and H. Sudheer in their paper discussed about the new voltage controller in photo-voltaic system for Stand-Alone Applications with battery energy storage. The output of the PV array is unregulated DC supply due to change in weather conditions. The maximum power is tracked with respect to temperature

and irradiance levels by using DC-DC converter. The perturbation and observes algorithm is applied for maximum power point tracking (MPPT) purpose.

2. Mrs Jaya N. Ingole, Mrs Dr. Madhuri A. Choudhary and Dr. R.D. Kanphade in their paper discussed about the use of PIC16F72 based solar charger controller for controlling the overcharging and discharging of a solar cell. It works by continuously optimizing the interface between the solar array and battery. First, the variable supply is fixed at 12.8V dc—the voltage of a fully charged battery— and linked to the battery point of the circuit. Cut Off of battery from load voltage is 10.8 volt. A PIC16F72 for small size and inbuilt analog inputs is used to determine voltage level of battery and solar panel. It also describes how the disadvantages of analog circuit are overcome by this controller.

3. Awang Jusoh , Tole Sutikno , Tan Kar Guan and Saad Mekhilef in their paper discussed on Favourable Maximum Power Point Tracking Systems in Solar Energy with different types of maximum power point tracking (MPPT) techniques for solar photovoltaic (PV) application. Since the PV output power is known affected by sun radiation and temperature, it is necessary to search for an effective method for extracting maximum amount of power from PV cell/modules. In this study, a total of seven control algorithms were selected, comprising the most popular methods among the established techniques.

4. Mahinda Vilathgamuwa “Voltage Sag Compensation With Energy Optimized Dynamic Voltage Restorer”, A new part advanced multiloop control scheme has been planned for the dynamic voltage restorer. A Kalman filter is used to determine the supply voltage parameters such the control scheme may be completed in real time. Through analysis, simulation, and experimental measurements, it's shown that the planned theme is superior compared to the conventional in-phase injection technique in terms of energy saving and dynamic performance. Such characteristics are highly desirable because the design is seen to end in a lot of economical restorer which might improve the ride-through capability of sensitive loads and industrial processes.

All the reviews given by different authors having some advantages and disadvantages, and these methods having some gaps these are as follows,



1. These models are not totally enough to study all parameters such as I-V and P-V characteristic of solar PV array including physical parameters such as saturation current, ideality factor series and shunt resistance etc.
2. Some gaps are shown in this review regarding simulation study the proposed model have some helpful parameters to fulfill these gaps.

### III. EQUIVALENT CIRCUIT OF SOLAR CELLS

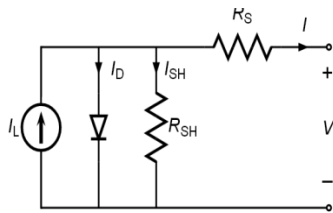

Fig-1

The equivalent circuit of solar PV cell shown in fig 1. The current source  $I_{ph}$  represents the cell photocurrent,  $R_{sh}$  and  $R_s$  are the intrinsic shunt and series resistance of solar cell here it is noted that the value of  $R_{sh}$  is very large and  $R_s$  very small so the relation between photo current, diode current and current flow in shunt resistance is given by.

$$I = I_L - I_D - I_{SH} \dots (1)$$

Now for getting the diode current following parameters can be kept in analysis

$$I_D = I_0 \{ \exp (V_j / N V_T) - 1 \} \dots (2)$$

Here we can put  $V_T = kT/q$  the thermal voltage at  $25^\circ C$ ,  $V_T = 0.0259$  volt by the ohms law the current divided through the shunt field resistor is

- $I_0$  = reverse saturation current
- $n$  = diode ideality factor
- $q$  = elementary charge
- $k$  = Boltzmann's constant
- $T$  = absolute temperature

$$I_{SH} = V / R_{SH} \dots (3)$$

Where  $R_{SH}$  = shunt resistance

Substituting the value of equation (2), (3) in equation (1) produces the characteristics equation of solar cell. Which relates solar cell parameters to the output current and voltage.

$$I = I_L - I_0 \{ \exp (V + I R_s / N V_T) - 1 \} - V + I R_s / R_{SH}$$

### Cell Temperature

Temperature affects the characteristic equation in two ways: directly, via  $T$  in the exponential term, and indirectly via its effect on  $I_0$  (strictly speaking, temperature affects all of the terms, but these two far more significantly than the others). While increasing  $T$  reduces the magnitude of the exponent in the characteristic equation, the value of  $I_0$  increases exponentially with  $T$ . The net effect is to reduce  $V_{OC}$  (the open-circuit voltage) linearly with increasing temperature. The magnitude of this reduction is inversely proportional to  $V_{OC}$ ; that is, cells with higher values of  $V_{OC}$  suffer smaller reductions in voltage with increasing temperature. For most crystalline silicon solar cells the change in  $V_{OC}$  with temperature is about  $-0.50\%/^\circ C$ , though the rate for the highest-efficiency crystalline silicon cells is around  $-0.35\%/^\circ C$ . By way of comparison, the rate for amorphous silicon solar cells is  $-0.20\%/^\circ C$  to  $-0.30\%/^\circ C$ , depending on how the cell is made.<sup>[2]</sup>

### IV. SIMULATION PARAMETERS

$I_{sc}(A)$	7.34A
$V_{oc}(V)$	0.6V
$R_s$	0.221ohm
$R_{SH}$	415ohm
$N_s$	36
Temp	25+273 C
Quality factor(N)	1.2
Irradiance	100, 500, 1000 w/m <sup>2</sup>

A simple model of Solar cell with PV array including fundamental component of diode, current source, shunt and series resistor connected in parallel is modeled in simulink tool. this simulation is based on basic equation of solar cell at different parameters.

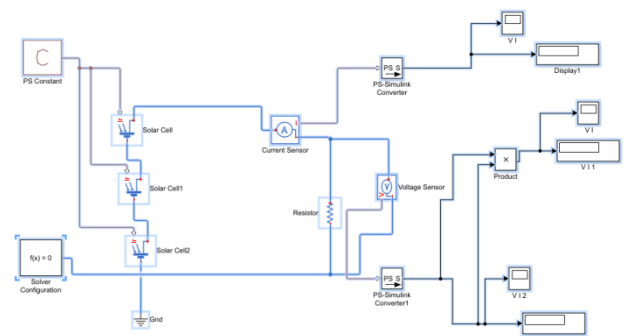

Fig2. solar model in simulink



V. RESULT ANALYSIS

The solar cell is a basic block for obtaining PV system it produces about 1W of power. For getting high power cells are connected in series and parallel circuits on a panel. The equivalent circuit characteristic of PV module are generally represented by I-V and P-V curves.

Result shows the I-V and P-V characteristics under varying irradiance with constant temperature here the solar irradiance changes with values of 1000,800,600,400 W/m<sup>2</sup> while temperature keeps constant at 25 °c.

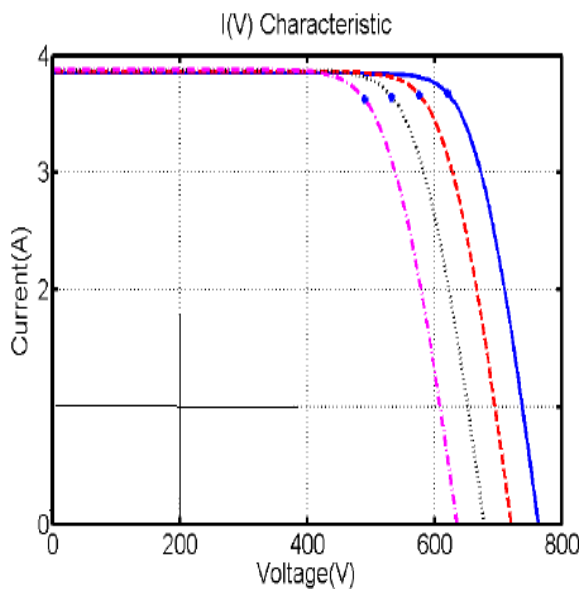

Fig-3

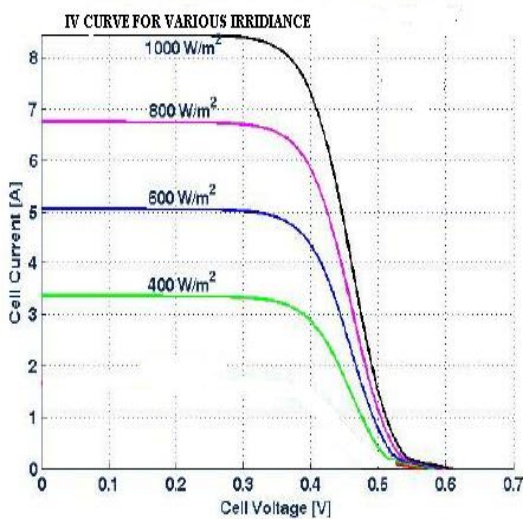

Fig-4

VI. SOLAR POWER GENERATION

Year	Solar power generation		
	INDIA(BKwh)	CANADA(MW)	USA(Gwh)
2013	3.35	1500	9,253
2014	4.60	2000	18,321
2015	7.45	2500	26,473
2016	12.9		36,754

Solar power in India is fast developing industry. As on sep 2017 the country solar grid had a cumulative capacity of 16.20GW. In the given chart solar power generation of India, Canada, USA is as follows

India quadrupled its solar-generation capacity from 2,650 MW on 26 May 2014 to 12,289 MW on 31 March 2017. The country added 3.01 GW of solar capacity in 2015-2016 and 5.525 GW in 2016-2017, the highest of any year, with the average current price of solar electricity dropping to 18% below the average price of its coal-fired counter part.<sup>[8]</sup>

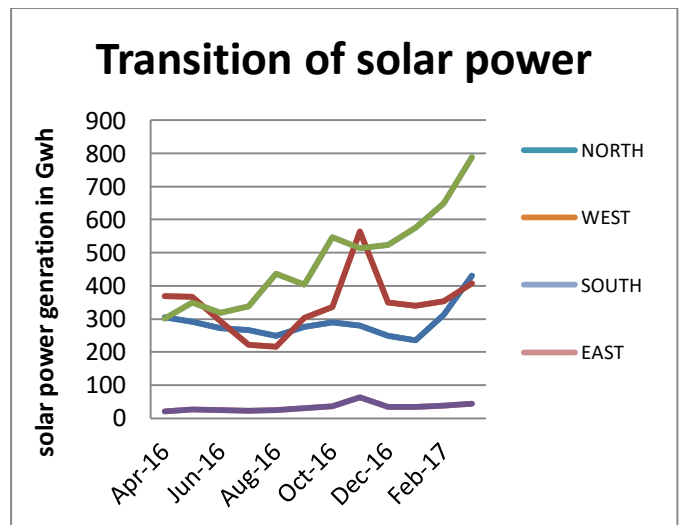

Fig-5

Graph shown in fig 2 represents the solar power generation in India in various region from april-2016 to march-2017. In this graph absorbed that power generation is decreasing till January 2017 but from feb 2017 its increasing. This represents the transition rate of solar power.

The charge controller takes the energy from the solar panel and converts the voltage so its suitable for battery charging. The supply voltage for 12v battery bank is 16v. solar battery charger works on the principle that the charge control circuit will generate the constant voltage.

The charging current permits to LM317 voltage regulator using D1 diode.

A case example is presented having following specifications. [9]

Solar panel rating	5W/17V
Output voltage	Variable(5V-14V)
Maximum output current	0.29A
Drop voltage	2.75V
Voltage regulation	+/-100MV

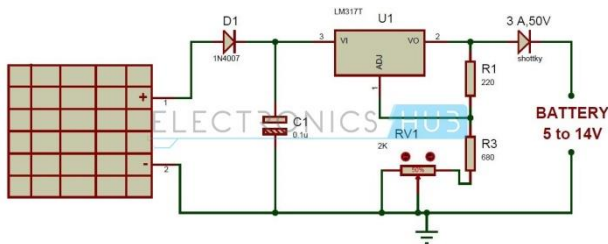

Fig-6

## VII. SOLAR TRACKING

Solar tracker is a device for charging the solar panel for getting the solar power from the sun. Concentrators especially in solar cell application require a high degree of accuracy to ensure that the concentrators sunlight is directed precisely to powered device. There are three types of solar tracking system. [11],[12]

- 1) Azimuth tracking
- 2) Attitude/elevation tracking
- 3) Dual axis tracking

### Concentrators

Typical concentrators are constructed from parabolic mirrors which reflect the Sun's parallel rays on to a single spot at the focus of the mirror.

### Parabolic Dish

A parabolic dish will capture the energy intercepted by the dish and concentrate it on a suitable heat absorber located at the focus. The amount of energy captured and hence the temperature rise of the absorber will be proportional to the area of the dish. Size limitations of the dish limit its application to small systems of from 10kW to 50kW.

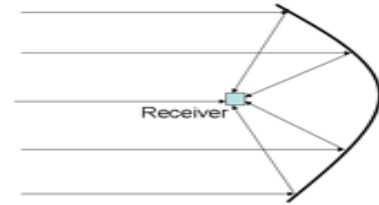

Parabolic Dish Solar Concentrator

- **Parabolic Trough**

Larger systems use arrays of parabolic trough shaped mirrors oriented north-south to concentrate the solar radiation. They usually also include a tracking system to track the Sun's path throughout the day.

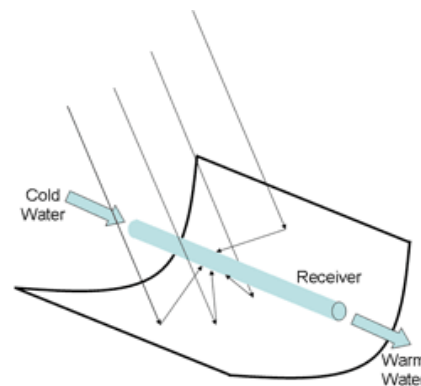

Parabolic Trough Solar Concentrator

## VIII. CONCLUSION

As the solar power system is very advantageous and solar resources is unlimited of various countries tried to take the use of such resources but they face many difficulties in actually implementing the technology. So every country tried to make to control the battery charging with many types of charge controller that is low size and cost.

## IX. REFERENCES

- [1] A. Rostami, K. Abbasian, N. Gorji, "Efficiency Optimization in a Rainbow Quantum Dot Solar Cell", International Journal on Technical and Physical Problems of Engineering (IJTPE), Issue 7, Vol. 3, No. 2, pp. 106-109, June 2011.
- [2] M. Sojoudi, R. Madatov, T. Sojoudi, "Optimization of Efficiency of Solar Cells by Accelerated Electron ray to Have an Optimal and Constant Energy", International Journal on Technical and Physical Problems of Engineering (IJTPE), Issue 9, Vol. 3, No. 4, pp. 68-71, December 2011.

- [3] Yuncong Jiang, Jaber A. Abu Qahouq and Mohamed



Orabi, “Matlab/Pspice Hybrid Simulation Modeling of Solar PV Cell/Module”, Proceedings of Twenty-Sixth Annual IEEE Applied Power Electronics Conference and Exposition (APEC 2011), pp. 1244-1250.

[4] R.K. Nema, SavitaNema, and GayatriAgnihotri, “Computer Simulation Based Study of Photovoltaic Cells/Modules and their Experimental Verification”, International Journal of Recent Trends in Engineering, Vol 1, No. 3, pp. 151-156, May 2009.

[5] Sheriff M. A., Babagana B. and Maina B. T., “A Study of Silicon Solar Cells and Modules using PSPICE”, World Journal of Applied Science and Technology, Vol. 3., pp. 124-130, No.1, 2011.

[6] Yuncong Jiang, Jaber A. Abu Qahouq and I. Batarseh, “Improved Solar PV Cell Matlab Simulation Model and Comparison”, Proceedings of 2010 IEEE International Symposium on Circuits and Systems (ISCAS), pp 2770 - 2773, May-June, 2010.

[7].Eduardo Lorenzo (1994). Solar Electricity: engineering of Photovoltaic Systems. Progensa. ISBN 84-86505-55-0

[8].Antonio Luque & Steven Hegedus (2003). Handbook of Photovoltaic Science and Engineering. John Wiley and Sons. ISBN 0-471-49196-9.

[9].Jump up^ Jenny Nelson (2003). The Physics of Solar Cells. Imperial College Press. ISBN 978-1-86094-340-9.

[10]. N. D. Benavides, P. L. Chapman, “Boost Converter with a Inducto” Power Electronics Specialists Conference, 2007, PESC 2007, IEEE, pp. 1695-1700, June 2007.

[11] J. Marcos Alonso, Marco A. Dalla Costa, Manuel Rico-Secades, Jesus Cardesin and Jorge Garcia, “Investigation of a New Control Strategy for Electronic Ballasts Based on Variable Inductor”, IEEE Trans. on Industrial Electronics, Vol.55, No. , pp. 3-10, January, 2008.

[12] G. De Cesare, D. Caputo, A. Nascetti, “Maximum Power Point Tracker for Portble Photovoltaic Systems with Resistive-like Load”, Solar Energy, Vol. 80 , pp.982-987, 2006.

[13] J. M. Enrique, E. Duran, M. Sidrach-de-Cardona, J. M. Andujar, “ Theoretical Assessment of the Maximum Power Point Tracking Efficiency of Photovoltaic Facilities with Different Converter Topologies”, Solar Energy, Vol. 81, pp.31-38, 2007

[14] A. Oi, “Design and Simulation of Photovoltaic WaterPumping System”, Master Thesis, California PolytechnicState University, San Luis Obispo, CA, 2005.

# IJEAST

INTERNATIONAL JOURNAL  
OF ENGINEERING APPLIED SCIENCE  
AND TECHNOLOGY

## ABOUT IJEAST

International Journal of Engineering Applied Science and Technology (IJEAST) is a peer-reviewed, open access journal that publishes high-quality research papers in the field of Engineering, Applied Science and Technology.

IJEAST aims to provide a platform for researchers, academicians, and professionals to share their innovative ideas, research findings, and practical experiences with the global scientific community.

## FOCUS AREAS

- Engineering
- Applied Science
- Technology
- Innovation & Development
- Interdisciplinary Studies



### PEER REVIEWED

All submissions are rigorously peer reviewed to ensure quality.



### OPEN ACCESS

Free and unrestricted access to research for all.



### GLOBAL REACH

Connecting researchers and professionals worldwide.



### TIMELY PUBLICATION

We ensure a swift and efficient publication process.



For more information, visit our website  
[www.ijeast.com](http://www.ijeast.com)



INTERNATIONAL JOURNAL  
OF ENGINEERING APPLIED SCIENCE  
AND TECHNOLOGY

✉ [editor@ijeast.com](mailto:editor@ijeast.com)

🌐 [www.ijeast.com](http://www.ijeast.com)

📍 India



2455-2143