



# IJEAST

INTERNATIONAL JOURNAL  
OF ENGINEERING APPLIED SCIENCE  
AND TECHNOLOGY



**VOLUME : 7    ISSUE : 01    Print / Issue Publication Date: 07-Jul-2022**



**ISSN : 2455-2143**



**DOI : 10.33564/IJEAST.2022.v07i01.035**

Indexed In



[WWW.IJEAST.COM](http://WWW.IJEAST.COM)

[editor@ijeast.com](mailto:editor@ijeast.com)

# STUDY OF SOIL STRUCTURE INTERACTION AND SEISMIC RESPONSE OF BASE ISOLATED STEEL FRAME WITH BUCKLING RESTRAINED BRACED DAMPING SYSTEMS

Roshanee Bajirao Chitte

P.G. Student, Department of Civil Engineering [Structures]  
Sinhgad College of Engineering Pune - 411041, India

**Abstract:** In this study, the project relies on the, process in which the response of the soil influences the motion of the structure and the motion of the structure influences the response of the soil is termed as Soil Structure Interaction. In this case neither the structural displacements nor the ground displacements are independent from each other. The phrase ‘soil-structure interaction’ may be defined as influence of the behaviour of soil immediately beneath and around the foundation on the response of soil-structure subjected to either static or dynamic loads.

A buckling-restrained brace (BRB) is a structural brace in a building, designed to allow the building to withstand cyclical lateral loadings, typically earthquake-induced loading. It consists of a slender steel core, a concrete casing designed to continuously support the core and prevent buckling under axial compression, and an interface region that prevents undesired interactions between the two.

It consists of four models of clay, sand and silt, each one has models as without bracing, with X-bracing, with inverted V-bracing and Y-bracing. It is concluded that X-bracing has less displacement, storey drift and high base shear compared to others. Also, X-bracing with SSI has less displacement, storey drift and high base shear compared to without SSI.

**Keywords:** Soil Structure Interaction, Seismic Response, Base Isolated Steel Frame, BRB Damping System.

## I. INTRODUCTION

The process in which the response of the soil influences the motion of the structure and the motion of the structure influences the response of the soil is termed as Soil Structure Interaction. In this case neither the structural displacements nor the ground displacements are independent from each other. The phrase ‘soil-structure interaction’ may be defined as influence of the behaviour of soil immediately beneath and around the foundation on the response of soil-structure subjected to either static or

dynamic loads”. A foundation is a means by which superstructure interfaces with underlying soil or rock. Under static conditions, generally only vertical loads of structure need to be transfer to supporting rock. In seismic environment, the loads imposed on a foundation from a structure under seismic excitation can greatly exceed the static vertical loads as even produce uplift; in addition, there will be horizontal forces and possibly movement at foundation level. The soil and rock at site have specific characteristics that can significantly amplify the incoming earthquake motions travelling from the earthquake source. SSI effects become prominent and must be regarded for structures where P delta effects play a significant role structures with massive or deep seated foundations, slender tall structures and structures supported on very soft soils with average shear velocity less than 100 m/s. A buckling-restrained brace (BRB) is a structural brace in a building, designed to allow the building to withstand cyclical lateral loadings, typically earthquake-induced loading. It consists of a slender steel core, a concrete casing designed to continuously support the core and prevent buckling under axial compression and an interface region that prevents undesired interactions between the two. Braced frames that use BRBs – known as buckling-restrained braced frames, or BRBFs – have significant advantages over typical braced frames.

## II. OBJECTIVES

- To estimate the effect of SSI on the seismic Response of multi story isolated steel frame with BRB Damping System.
- To study the parameter such as story drift, Base Shear, Displacement, Vertical Settlement are compare along with parameters which is obtain from seismic analysis of steel frame.
- To evaluate effectiveness of damping system considering SSI structural improvement of earthquake resisting structure.



### III. METHODOLOGY

In this study, Soil – structure interaction plays an important role in the behavior of foundations. For structures like beams, piles, mat foundation and box cells it is very essential for consider the Displacement characteristics of soil and flexural properties of foundations. It can be seen that when interaction is taken into account, the true design values arrived-at may be quite different from those worked out without considering interaction. In general in most of the case interaction causes reduction in critical design values of the shear and moments etc. However, there may be quite a few locations where the values show an increase. Because of these possibilities have their own roles to play in economy and safety of structure. Several studies have indicated that the maximum bending moment in a foundation raft or beam could be substantially affected by interaction with superstructure. Reduction as high as 80% is reported in certain cases. The rigidity of foundation raft relative to soil is of extremely high values of bending moments in relative rigid rafts as compared to those in flexible rafts. An elastic-plastic analysis also indicates similar trend, although to a much lesser degree. An equal settlement is the severest cause for cracking and even failure of superstructures. On the other hand, rigidity of superstructure helps in reducing differential settlements. Of course to realize this, only interactive analysis has to be carried out.

#### **Soil Foundation Interaction Problem:**

The study of the interaction between foundation and supporting soil media is of fundamental importance to both geotechnical and structure engineers. Results of such study can be used in the structural design of the foundation and in the analysis of the stresses and Displacements with the supporting soil medium. In-situ soils are commonly anisotropic and non-homogeneous and display markedly non-linear, irreversible and time dependant characteristics. The behaviour of such soils is expected to be influenced by following factors.

- (i) The shape, sizes and mechanical properties of the individual soil particles.
  - (ii) The configuration of the soil structure.
  - (iii) The inter-granular stresses and stress history
  - (iv) The presence of soil moisture, the degree of saturation and the soil permeability
- The solution of any interaction problem on the basis of all above factors is very difficult, laborious and impracticable, realistic and purposeful solutions can achieved by idealizing the behaviour of the

soil by considering specific aspects of its behaviour. The simplest idealization of response naturally occurring soils assumes linear elastic behaviours of the supporting soil medium. This idealization also assumes the surface of the soil medium to form the soil foundation interface and the soil medium is represented by elastic medium occupying a half-space region. Though these assumptions are not always satisfied by in-situ soils, these considerably simplifying the solution and provide useful information to number of practicable problems in geotechnical engineering. Various idealization soil behaviour models will be introduced afterwards.

#### **Methods of soil modelling**

The generalized stress-strain relations for soils, don't represent even the gross physical properties of a soil mass, the idealized models are observed to provide a useful description of certain features of soil media under limited boundary conditions. The idealized soil behaviour particularly reduces the analytical rigor spent in the solution of complex problems in geotechnical engineering.

The idealization will depend on a variety of factors such as:

- The type of soil.
- The soil conditions,
- The type of foundation,
- The nature of external loading,
- The method of construction,
- The purpose and life span of the structure and
- The economic considerations.

Various damping technique

#### • **Base Isolation**

The objective of seismic isolation systems is to decouple the building structure from the damaging components of the earthquake input motion, i.e. to prevent the superstructure of the building from absorbing the earthquake energy. The entire superstructure must be supported on discrete isolators whose dynamic characteristics are chosen to uncouple the ground motion. Some isolators are also designed to add substantial damping. Displacement and yielding are concentrated at the level of the isolation devices, and the superstructure behaves very much like a rigid body. Because of base isolation time period of system elongates. Figure 3.1 shows the change in the time period of the building. Position A is the position of normal building. Position B is the new position of building structure, this change in position is because of use of base isolation in the building.

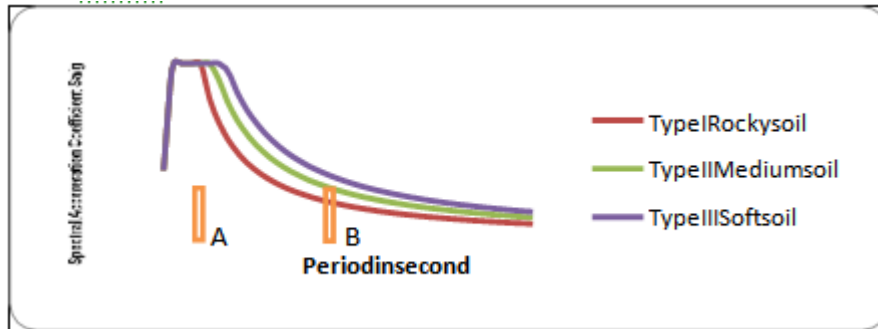

**Figure: 2.1** Position of building on Response Spectra as per IS 1893-2016

Modern structural protective system can be divided into three groups as shown in fig.

**Table 2.1** Structural Protective System

Seismic Isolation	Passive Energy Dissipation	Semi-active and Active control
Elastomeric Bearing	Metallic Damper	Active Damping System
	Friction Damper	Active Mass Damper
Lead Rubber Bearing	Viscoelastic Damper	Variable stiffness or damping system
	Viscous Fluid Damper	Smart Material
Sliding Friction Pendulum	Tuned Mass Damper Tuned Liquid Damper	

**Bracing systems:**

A braced frame is a structural system commonly used in structures subject to lateral loads such as wind and seismic pressure. The members in a braced frame are generally made of structural steel, which can work effectively both in tension and compression. The beams and columns that form the frame carry vertical loads, and the bracing system carries the lateral loads. The positioning of braces, however, can be problematic as they can interfere with the design of the façade and the position of openings. Types of bracing

- **Single diagonals**

Trussing, or triangulation, is formed by inserting diagonal structural members into rectangular areas of a structural frame, helping to stabilize the frame. If a single brace is used, it must be sufficiently resistant to tension and compression.

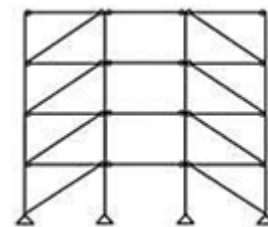

**Fig 2.2** Single diagonals

- **Cross-bracing**

Cross-bracing (or X-bracing) uses two diagonal members crossing each other. These only need to be resistant to tension, one brace acting to resist sideways forces at a time depending on the direction of loading. As a result, steel cables can also be used for cross-bracing.



**Fig 2.3 Cross - diagonals**

However, this provides the least available space within the façade for openings and results in the greatest bending in floor beams.

- **K-bracing**

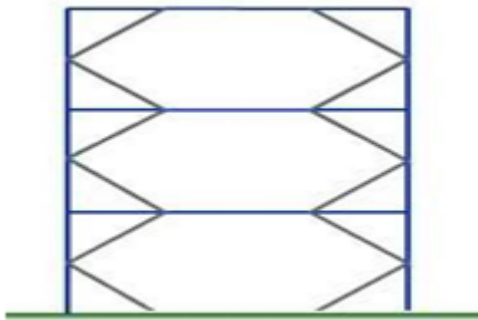

**Fig 2.4 K-bracing**

Braces connect to the columns at mid-height. This frame has more flexibility for the provision of openings and results in the least bending in floor beams. K-bracing is generally discouraged in seismic regions because of the potential for column failure if the compression brace buckles.

- **V-bracing**

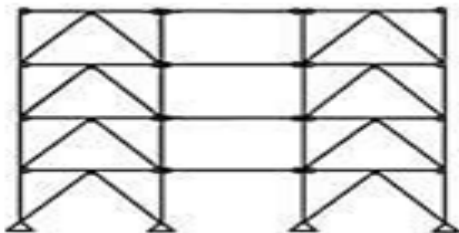

**Fig2.5V-bracing**

This involves two diagonal members extending from the top two corners of a horizontal member and meeting at a centre point at the lower horizontal member, in the shape of a V. Inverted V-bracing (also known as chevron bracing) involves the two members meeting at a centre point on the

upper horizontal member.

Both mean that the buckling capacity of the compression brace is likely to be significantly less than the tension yield capacity of the tension brace. This can mean that when the braces reach their resistance capacity, the load must instead be resisted in the bending of the horizontal member.

- **Eccentric bracing**



**Fig2.6 Eccentric bracing**

This is commonly used in seismic regions. It is similar to V-bracing but instead of the bracing members meeting at a centre point there is space between them at the top connection. Bracing members connect to separate points on the horizontal beams. This is so that the 'link' between the bracing members absorbs energy from seismic activity through plastic Displacement. Eccentric single diagonals can also be used to brace a frame.

**Buckling Restrained Brace**

Buckling restrained braced frames (BRBFs) for seismic load resistance have been widely used in high seismic regions in the recent years. BRBs or buckling restrained braces are structural dampers proposed in seismic resistance design of structures. They comprise of two components: A steel core and a Buckling Restrained Mechanism (BRM). The steel core is laterally restrained by BRM which is a steel tube filled with cement mortar or concrete or air gap with an unbonded material between the two. The core can yield in both compressions as well as in tension, which results in comparable yield resistance and ductility thus exhibiting a stable hysteric behavior accompanied by enhanced ductility during earthquakes.

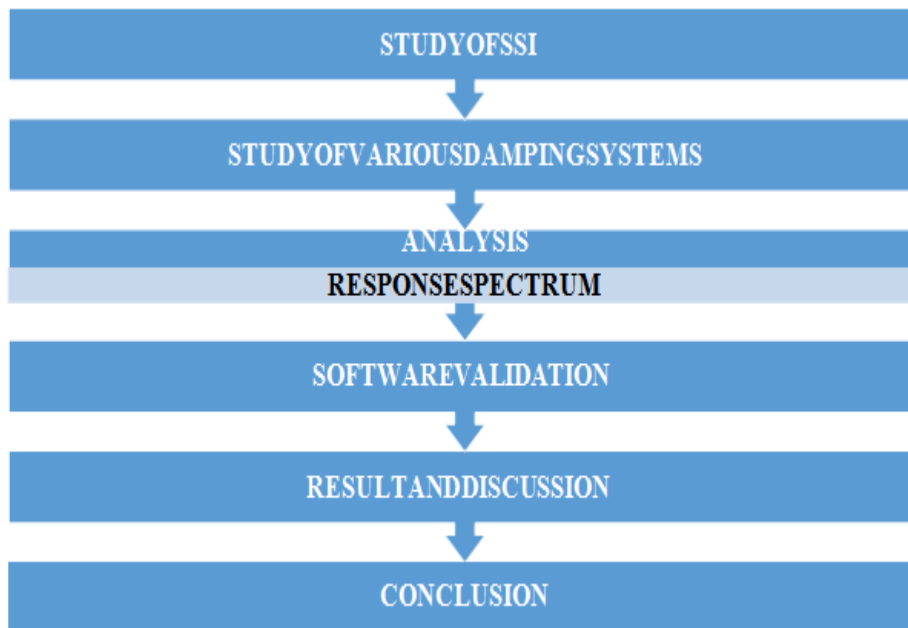

**Fig 2.7 Buckling Restrained Brace**

**Response Spectrum Method**

Response spectrum analysis is the method to estimate the structural response to short, nondeterministic, transient

**Flowchart of Methodology**



**IV. MODELLING**

**General:**

The objective of this study is to develop efficient building models by using combination of braced frames. Four types of multi storied braced frame models are developed in seismic zone and evaluated its structural performance with respect to member strength, ductility and inter storey drift. Linear dynamic method used for seismic analysis and the results are verified by software. The results of all four models are analyzed and selected an efficient structural

dynamic events. For examples of events like earthquakes and shocks.

A response spectrum is a function of frequency or period, showing the peak response of a simple harmonic oscillator that is subjected to a transient event. The response spectrum is a function of the natural frequency of the oscillator and of its damping.

**Design Lateral Force**

It is the horizontal seismic force prescribed by this standard, that shall be used to design a structure.

**Design Seismic Base Shear**

It is the total design lateral force at the base of a structure.

**Storey Drift**

It is the displacement of one level relative to the other level above or below.

model for design of eight storied commercial building.

**Problem Statement:**

The steel concrete composite building used in this study is eight storied (G+7). building have same floor plan with 5 bays having 4m distance along longitudinal direction and 3 bays having 5m distance along transverse direction as shown in figure.

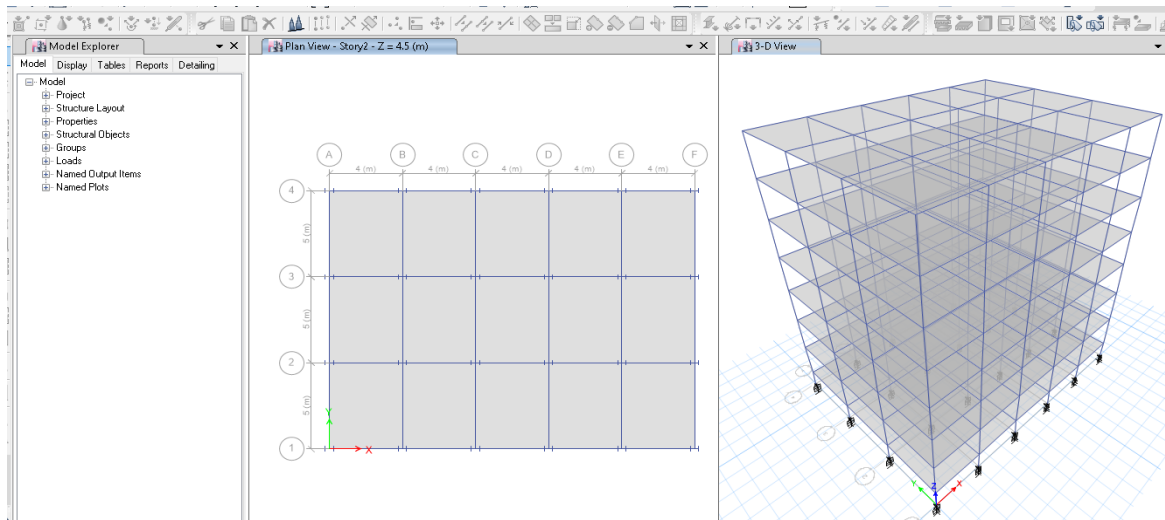

**Fig 3.1: Building Plan**

**Model Description:**

**Table 3.1 Model Description**

Models for clay	Models for sand	Models for Silty
1. Normal model without bracing	5. Normal model without bracing	9. Normal model without bracing
2. With X bracing	6. With X bracing	10. With X bracing
3. With Inverted V bracing	7. With Inverted V bracing	11. With Inverted V bracing
4. With Y bracing	8. With Y bracing	12. With Y bracing

**DESIGN DATA**

**Design data**

Model: G+7  
 Seismic zone: III Zone factor: 0.16  
 Importance factor: 1 Height of building: 31.5 m Floor height: 3.00m  
 Depth of foundation: 1.5 m Plan size: 20 m X 15 m Type of soil: Medium  
 Slab depth: 120 mm thick for R.C.C. Wall thickness: 230 mm.

**Material Properties**

Unit weight of masonry: 20kN/m<sup>3</sup>  
 Unit weight of R.C.C.: 25kN/m<sup>3</sup>  
 Unit weight of steel: 79kN/m<sup>3</sup>  
 Grade of concrete: M20 for R.C.C and Steel.  
 Grade of steel: HYSD bars for reinforcement Fe 415  
 Modulus of Elasticity for R.C.C.: 5000 X  $\sqrt{f_{ck}}$  N/mm<sup>2</sup>  
 Modulus of Elasticity for Steel: 2.1 x 10<sup>5</sup> N/mm<sup>2</sup>

**Load Consideration Dead load:**

Self Weight  
 Live load  
 Floor finish load

Seismic load

**Load Combination Consideration:**

Load combinations as per IS 1893-2016

**Dimensions consideration for design:**

For steel frame  
 Beam size: ISMB 300 @ 54.4 kg Column size: ISHB 500 @49.4kg  
 The steel damping used is ISA 110X110X10.

**Codes for analysis**

RCC design: IS 456:2000

**Link Properties Details**

Link property name = Star Seismic BRB 250  
 Mass = 44 kg  
 Weight = 250 kN  
 Link Type = Damper Exponential  
 Damping Ratio = 0.05  
 Section used for bracing = ISLB 600  
 Sectional Area=126.69 cm<sup>2</sup>,  
 Depth of the section = 600mm  
 Width of the section = 210mm

**Soil Properties**

**Table 3.2 Dynamic Properties of Soil**

Soil Type	G(kN/m <sup>2</sup> )	E(kN/m <sup>2</sup> )
Soft Soil	11500	32000
Medium Soil	21500	60000
Hard Soil	28500	80000

(Principals of Geotechnical Engineering) [14]  
 G=Shear Modulus; E = Elastic Modulus;  $\mu$ =Poisson's ratio of soil.

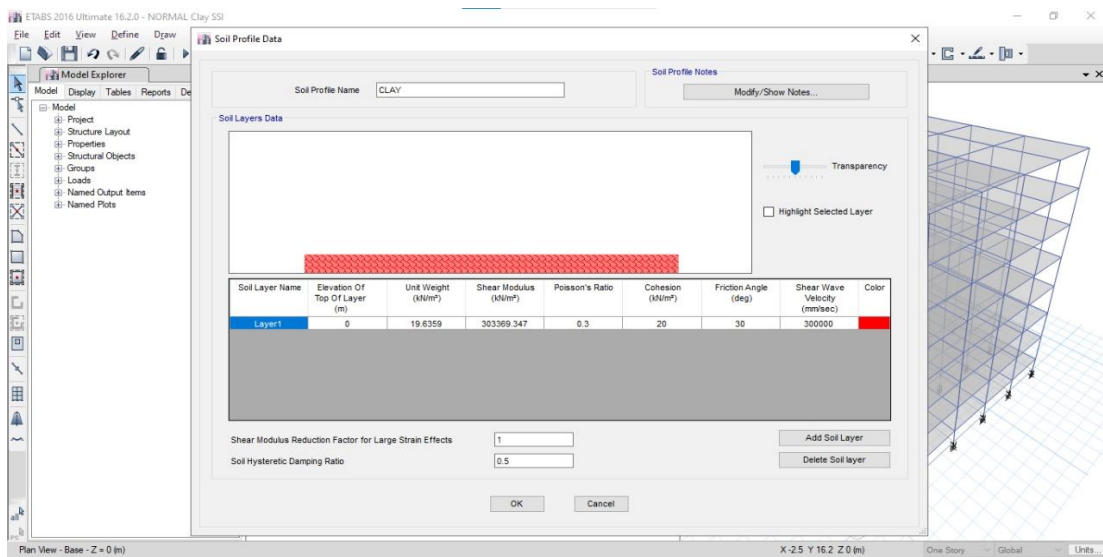

**Fig 3.2 Soil Profile Data**

In this fig, All soil properties are mentioned.

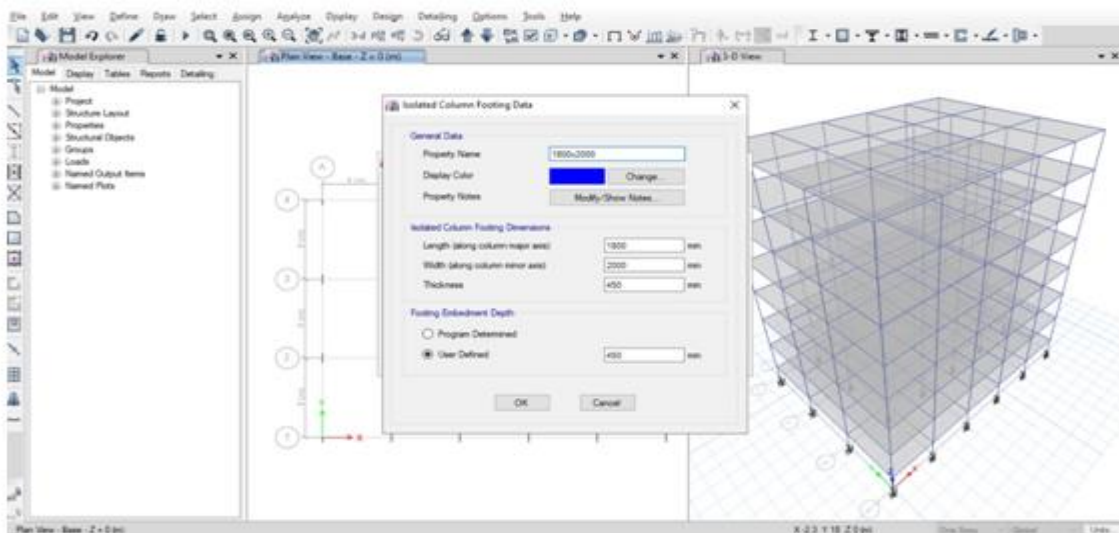

**Fig 3.3 Footing Data**

In this fig, length, width and depth of footing mentioned and Isolated Column footing is done.

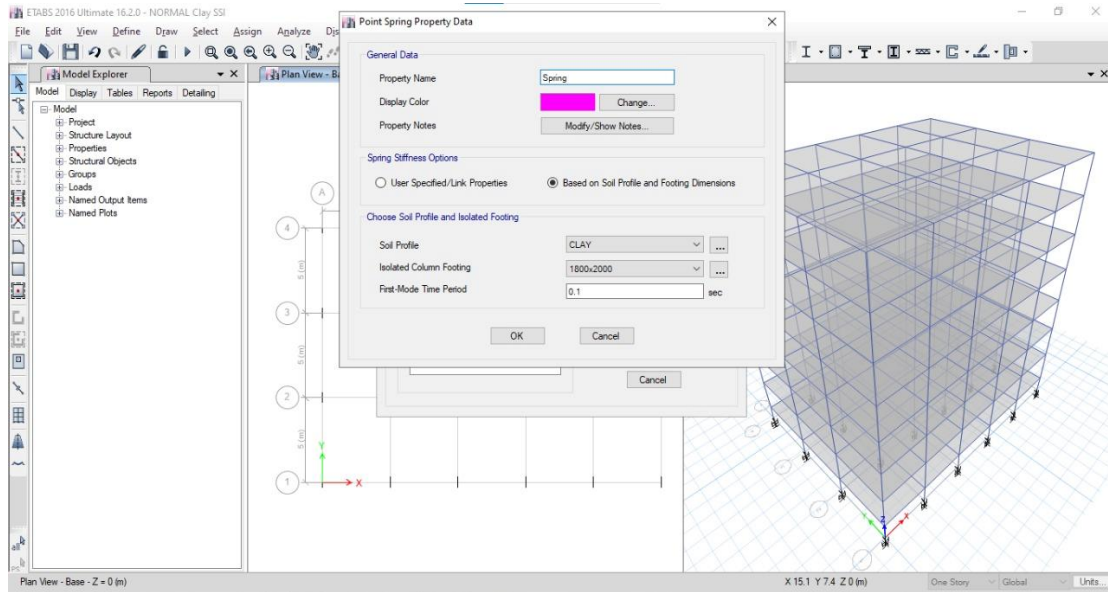

**Fig 3.4 Property Data**

In this fig, point spring property data mentioned and Spring stiffness option is selected based on soil profile and footing dimensions.

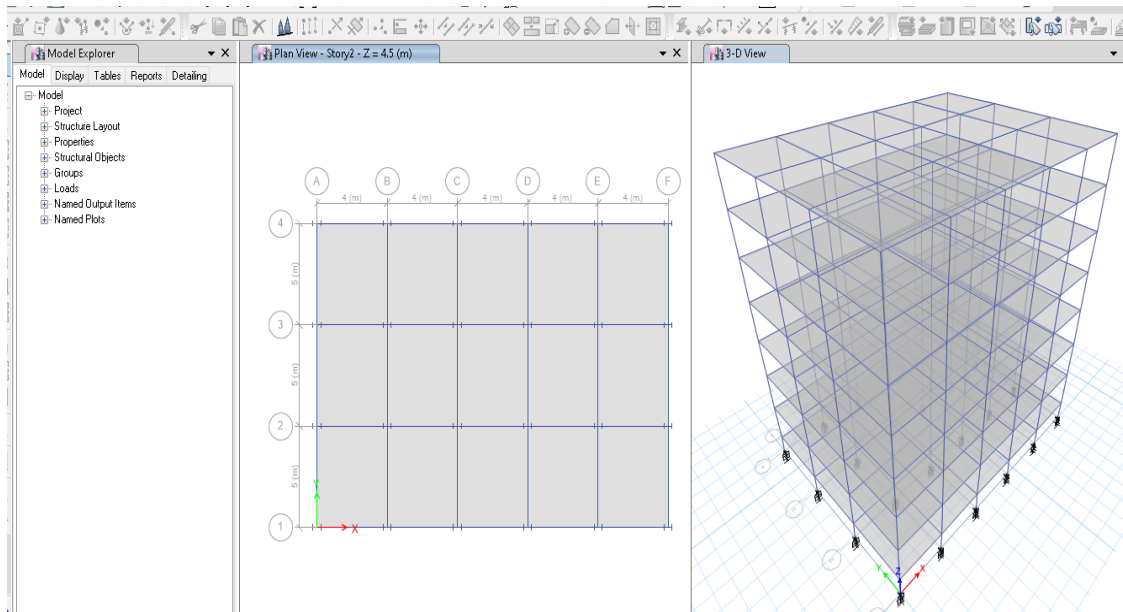

**Fig 3.5: Without Bracing**

In this fig, model is analyzed as Normal model and no bracing is provided.

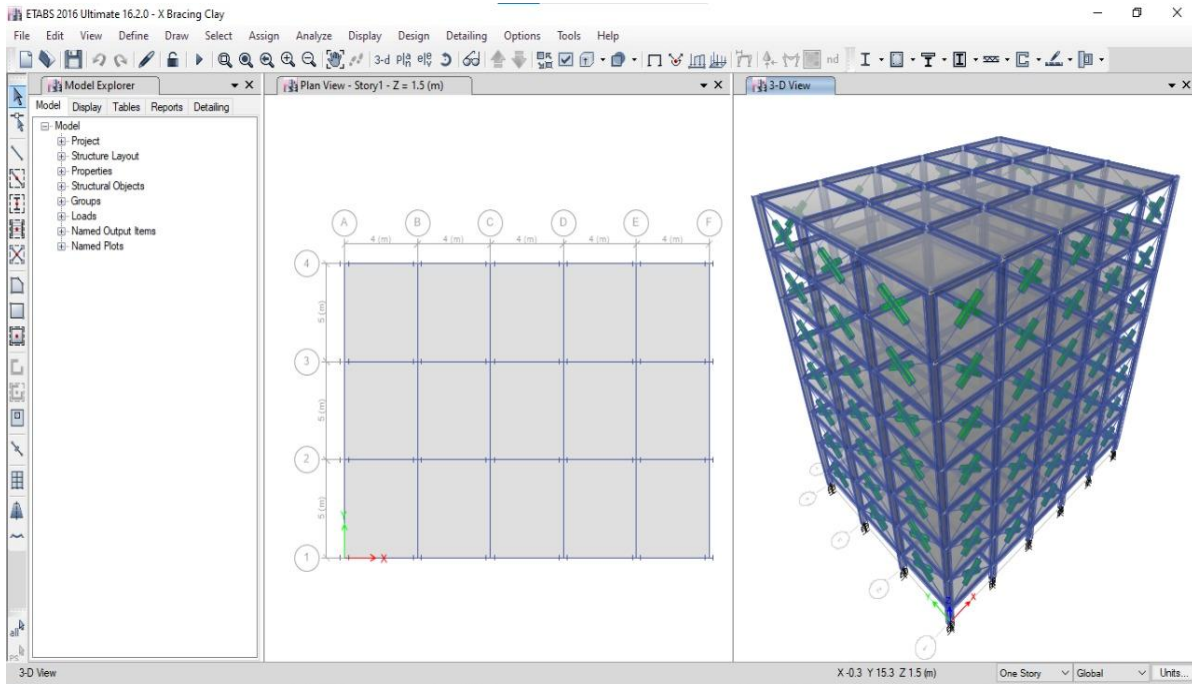

**Fig 3.6: With X Bracing**

In this fig model is created by providing X type of bracing.

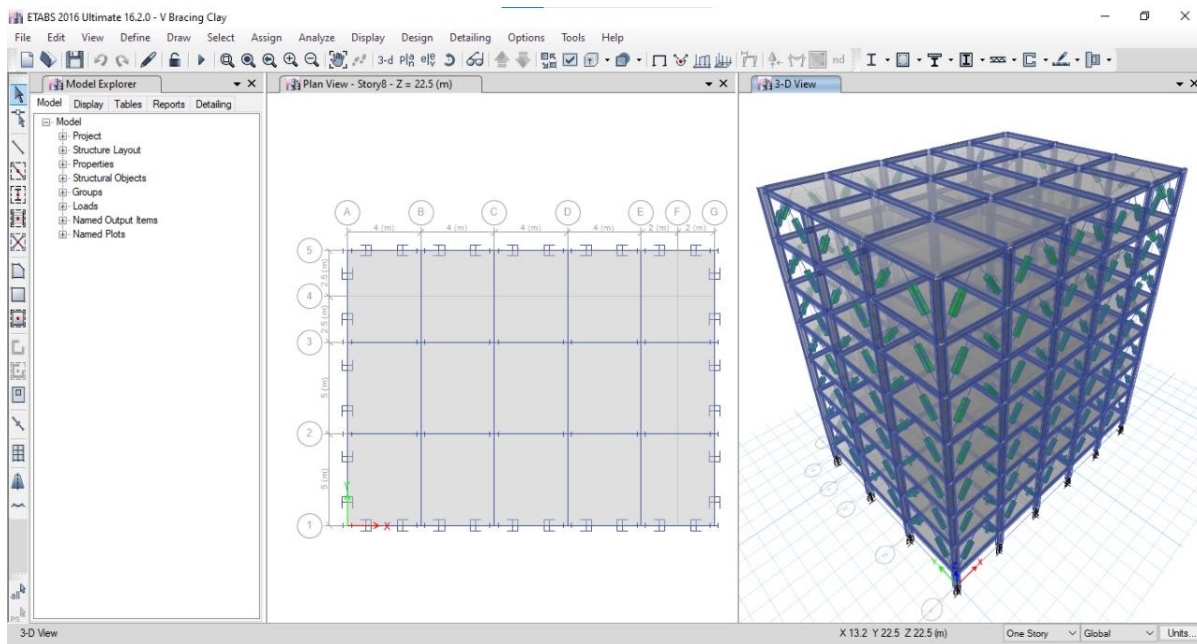

**Fig 3.7: With Inverted V Bracing**

In this fig model is created by providing Inverted V type of bracing.

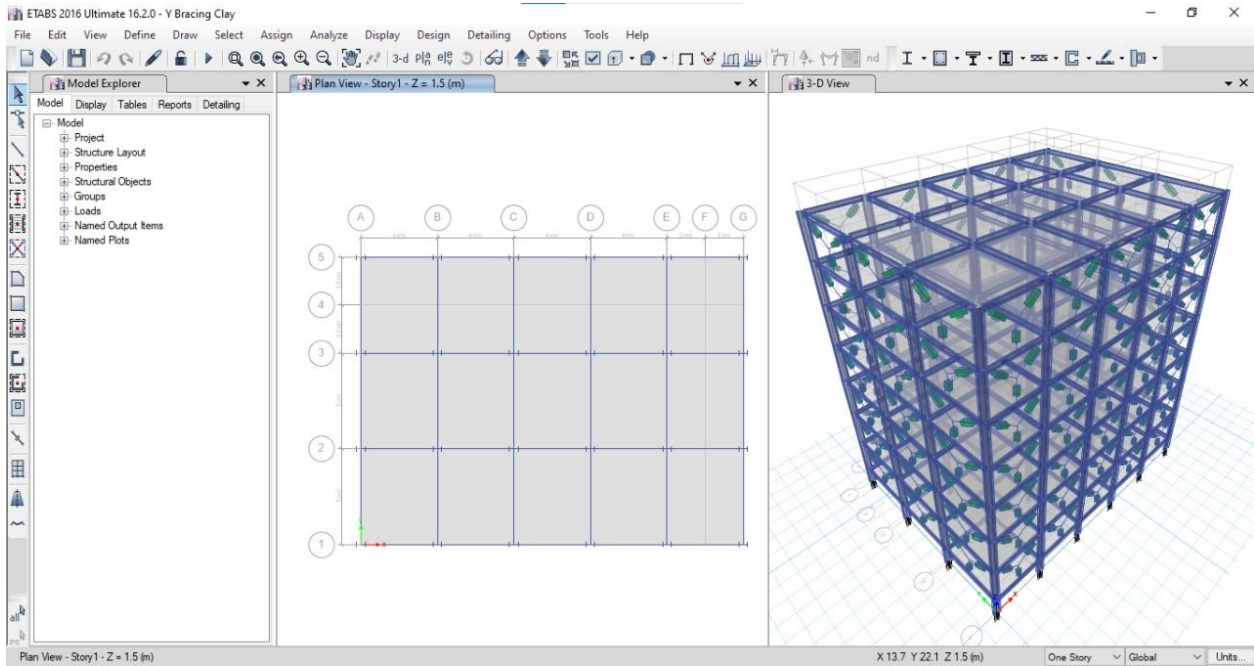

**Fig 3.8: With Y bracing**

In this fig, model is created by providing Y bracing.

## V. RESULT AND CONCLUSION

### Results for Clay

#### A. TOTAL DISPLACEMENT IN EQ<sub>x</sub> DIRECTION IN MM

**Table 4.1 Total Displacement in EQ<sub>x</sub> Direction for Clay in mm for X bracing**

TOTAL DISPLACEMENT IN EQ <sub>x</sub> DIRECTION				
STOREY	NORMAL	XBRACING	Inverted VBRACING	YBRACING
8	468.92	422.9495	445.21	444.21
7	445.01	401.4026	422.229	422.819
6	407.688	367.7593	387.115	388.274
5	339.227	321.3223	338.234	339.227
4	291.782	263.2346	277.089	277.888
3	247.554	195.4283	205.714	206.295
2	190.469	120.2976	126.629	126.979
1	64.296	40.60965	42.747	42.864
0	0	0	0	0

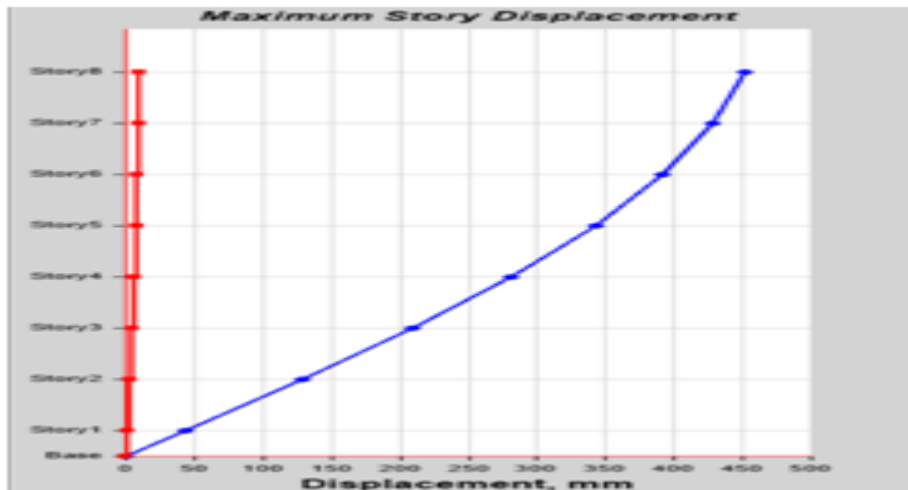
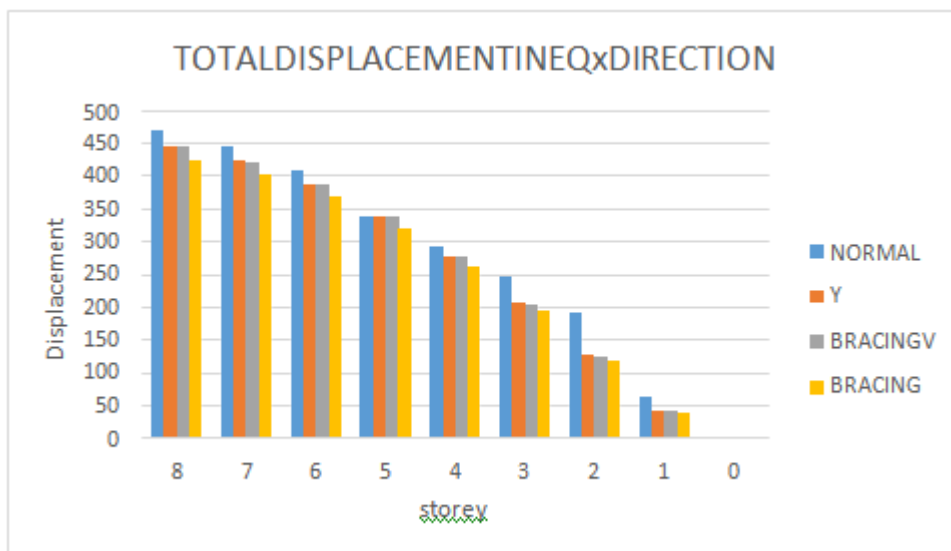

Fig 4.1 Total Displacement in EQx Direction for Clay for X bracing



Note: Here V bracing is Inverted V bracing

Graph 4.1 Total Displacement in EQx Direction for Clay

**CLAY**

Above graph shows Displacement in EQx direction for normal building, X bracing, Y bracing, inverted V bracing structure. As we can see that X bracing has the lower

Displacement than the normal, Y and inverted V bracing. X bracing has lower value than the normal, Inverted V and Y bracing by 9.8 %, 5%, 5.27% resp.

**B. TOTAL DISPLACEMENT IN EQy DIRECTION IN MM**

Table4.2 Total Displacement in EQy Direction for Clay

TOTAL DISPLACEMENT IN EQy DIRECTION				
STOREY	NORMAL	XBRACING	Inverted VBRACING	YBRACING
8	495.35	490.125	493.254	494.36
7	493.65	488.639	490.01	490.26



6	400.356	395.236	397.50	398.50
5	350.356	341.258	344.523	345.236
4	299.365	285.236	287.265	290.635
3	251.369	240.285	246.258	248.236
2	198.632	190.036	192.06	192.265
1	94.356	92.152	93.174	93.267
0	0	0	0	0

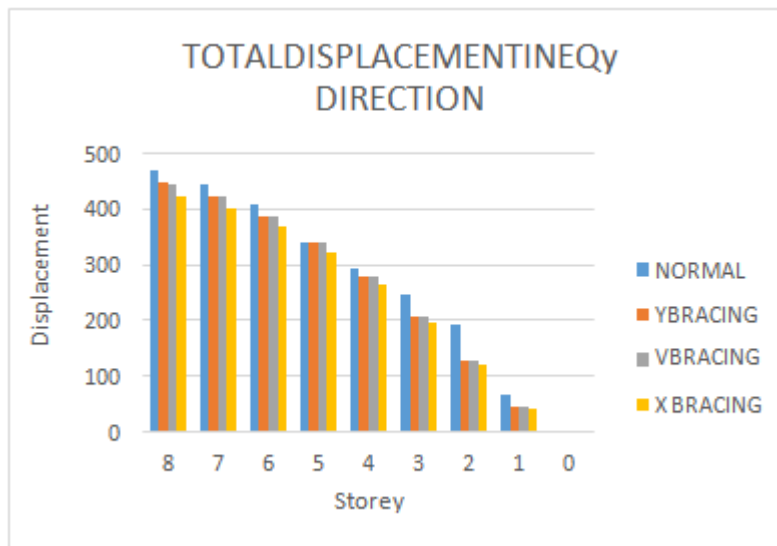

Note: Here V bracing is Inverted V bracing

**Graph 4.2 Total Displacement in EQy Direction for Clay**

**CLAY**

Above graph shows total Displacement in EQy direction for normal building, X bracing, Y bracing inverted V bracing structure. As we can see that X bracing has the lower

Displacement than the normal, Y and inverted V bracing. X bracing has lower value than the normal, inverted V and Y bracing by 1.04 %, 0.63%, 0.85% resp.

**A. STORY DRIFT IN EQx DIRECTION**

**Table 4.3 Story Drift in EQx Direction for Clay**

STORY DRIFT IN EQx DIRECTION				
STOREY	NORMAL	XBRACING	Inverted VBRACING	YBRACING
8	8.13225	7.894	7.97844	8.058224
7	12.58635	12.234	12.3624	12.48602
6	17.20635	16.739	16.91262	17.08175
5	21.3717	20.8	21.01506	21.22521
4	24.8283	24.173	24.42186	24.66608
3	27.4323	26.715	26.99022	27.26012
2	29.06085	28.309	28.6008	28.88681
1	29.6142	28.85	29.14752	29.439
0	0		0	0

Check: Drift should not exceed 0.004 times height of building  
 So the structure is safe.

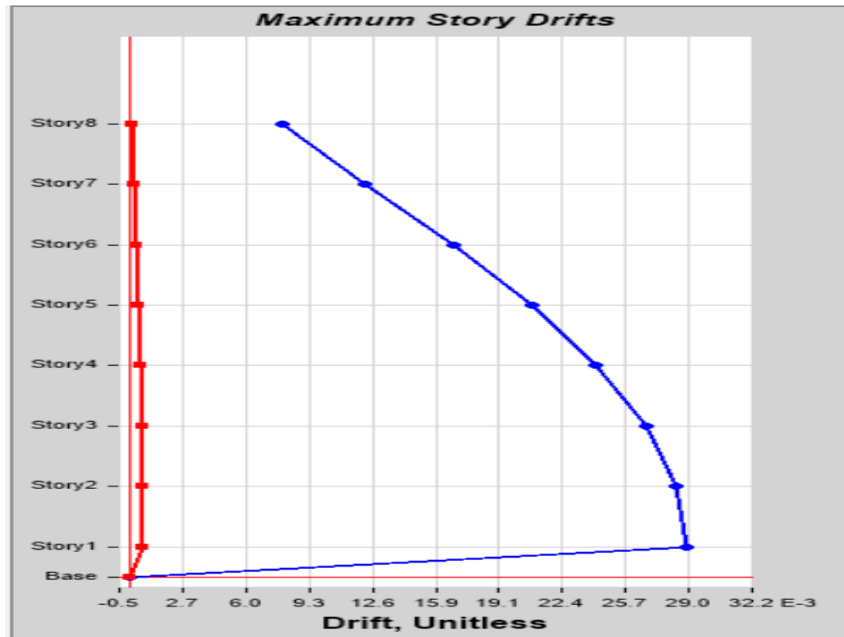

From graph, we can see that lateral displacement between two stories, so we can see change in the graph at the base.

**Fig 4.2 Story Drift in EQx Direction for Clay for X bracing**

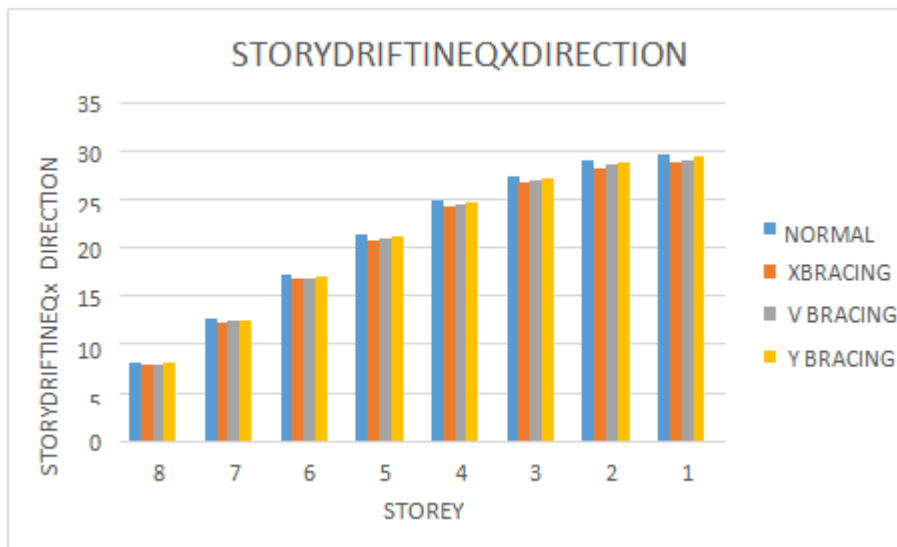

Note: Here V bracing is Inverted V bracing

**Graph 4.3 Story Drift in EQx Direction for Clay**

**CLAY**

Above graph shows story drift in EQx direction for normal building, X bracing, Y bracing, inverted V bracing structure. As we can see that X bracing has the lower story drift than

the normal, Y and inverted V bracing. X bracing has lower value than the Normal, inverted V and Y by 2.56 %, 1.6%, 0.67% resp.

**B. STOREY DRIFT IN EQy DIRECTION**

**Table 4.4 Storey Drift in EQy Direction for Clay**

STORY DRIFT IN EQy DIRECTION				
STOREY	NORMAL	XBRACING	Inverted VBRACING	YBRACING
8	17.7093	17.091	17.56459	17.38042
7	32.78205	31.722	32.58199	32.24035
6	46.4982	45.054	46.26348	45.77839
5	58.3233	56.548	58.05904	57.45027
4	68.05575	66.011	67.76988	67.05928
3	75.4467	73.202	75.14777	74.35981
2	80.16225	77.821	79.88062	79.04304
1	81.83175	79.451	81.55334	80.69822
0	0	0	0	0

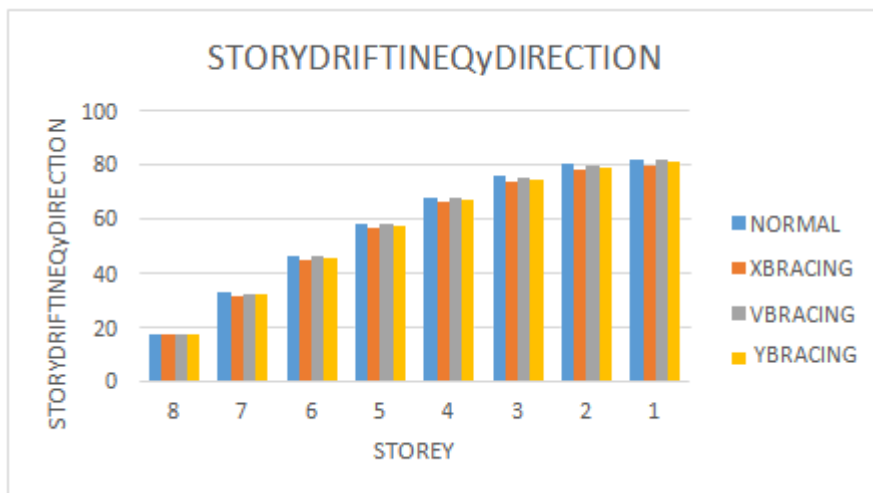

Note: Here V bracing is Inverted V bracing

**Graph 4.4 Storey Drift in EQy Direction for Clay**

**CLAY**

Above graph shows story drift in EQy direction for normal building, X bracing, Y bracing, inverted V bracing structure. As we can see that X bracing has the lower story drift than

the normal, inverted V, Y and bracing. X bracing has lower value than the Normal, inverted V and Y bracing by 2.90 %, 2.57%, 1.48% resp.

**A. BASE SHEAR IN EQx DIRECTION IN NEWTON**

**Table 4.5 Base shear in EQx Direction for Clay**

BASE SHEAR IN EQx DIRECTION				
STOREY	NORMAL	X BRACING	Inverted V BRACING	Y BRACING
8	1638.191	1676.5633	1650.762	1617.747
7	3142.178	3345.55809	3176.22	3112.696
6	4465.075	4707.33869	4517.904	4427.546



5	5612.479	5854.781	5681.574	5567.943
4	6560.542	6754.74933	6643.154	6510.291
3	7286.881	7599.24234	7379.883	7232.286
2	7764.704	7953.3454	7867.917	7710.559
1	7933.74	8163.06678	8039.525	7878.735
0	0	0	0	0

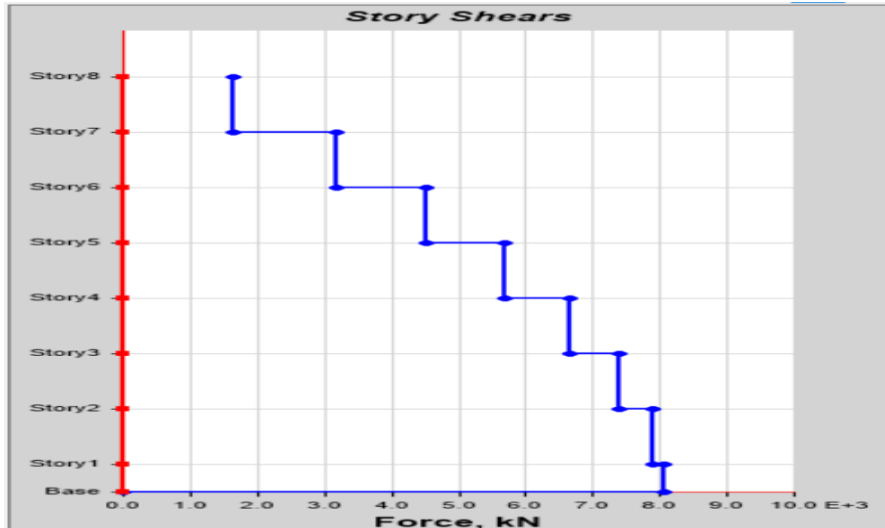

**Fig 6.3 Base shear in EQx Direction for Clay for X bracing**

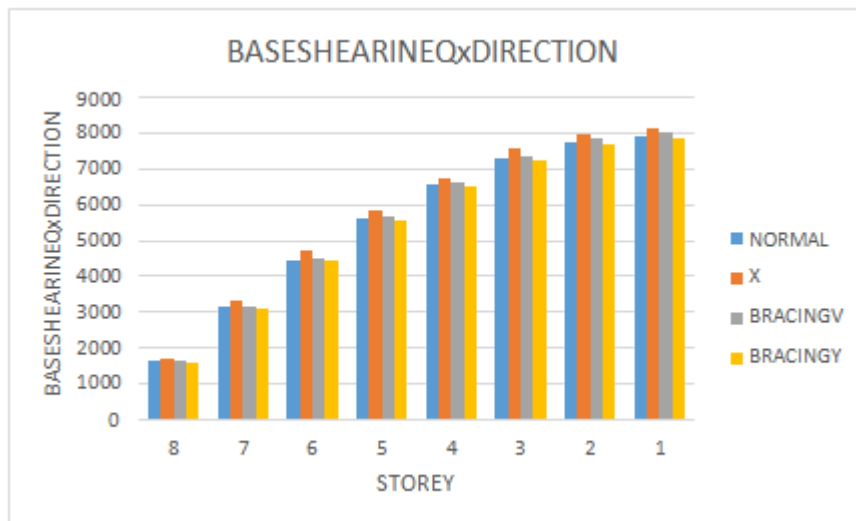

Note: Here V bracing is Inverted V bracing

**Graph 4.5 Base shear in EQx Direction for Clay**

Clay  
 Above graph shows base shear in EQx direction for normal building, X bracing, Y bracing, inverted V bracing structure. As we can see that X bracing has the higher base shear than

the normal, Y and inverted V bracing. X bracing has higher value than the Normal, inverted V and Y bracing building by 2.8 %, 1.5%, 3.48% resp.

**B. BASE SHEAR IN EQy DIRECTION IN NEWTON**

**Table 6.6** Base shear in EQy Direction for Clay

BASE SHEAR IN EQy DIRECTION				
STOREY	NORMAL	X BRACING	Inverted V BRACING	Y BRACING
8	1591.268	1606.495	1587.289	1571.416
7	3064.503	3106.334	3066.641	3035.975
6	4373.966	4439.289	4381.42	4337.606
5	5506.016	5591.635	5518.056	5462.875
4	6443.628	6546.108	6459.505	6394.91
3	7163.667	7279.179	7182.558	7110.732
2	7634.558	7762.886	7658.783	7582.195
1	7808.327	7939.95	7833.397	7755.063
0	0	0	0	0

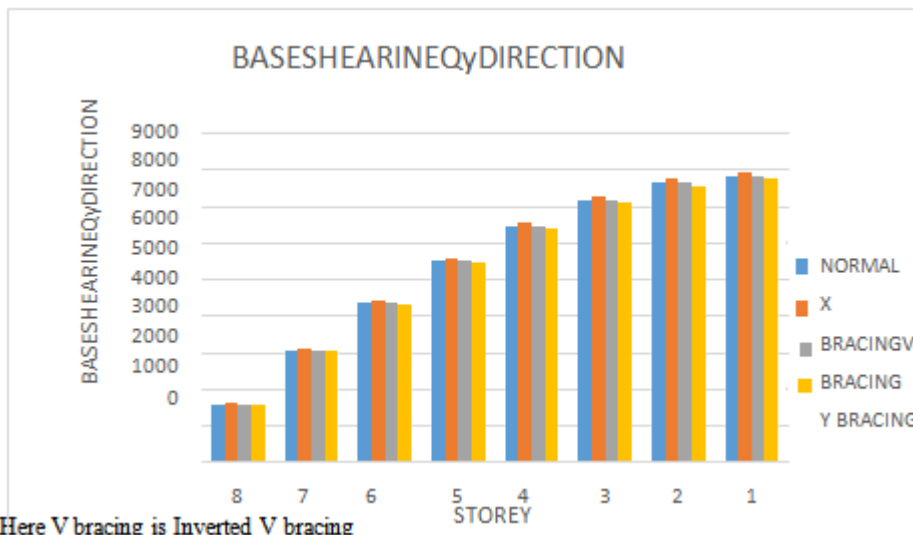

Note: Here V bracing is Inverted V bracing

**Graph 4.6** Base shear in EQy Direction for Clay

Clay  
 Above graph shows base shear in EQy direction for normal building, X bracing, Y bracing, inverted V bracing structure. As we can see that X bracing has the higher base shear than

the normal, Y and inverted V bracing. X bracing has higher value than the normal, inverted V and Y bracing by 1.65%, 1.34%, 2.32% resp.

**Results for Sand**

**A. TOTAL DISPLACEMENT IN EQx DIRECTION IN MM**

**Table 4.7** Total Displacement in EQx Direction for Sand

TOTAL DISPLACEMENT IN EQX DIRECTION				
STOREY	NORMAL	XBRACING	Inverted VBRACING	YBRACING
8	441.128	422.946	445.206	427.3978

7	418.554	401.375	422.5	405.6
6	383.407	367.744	387.099	371.615
5	334.931	321.307	338.218	324.6893
4	274.336	263.222	277.076	265.993
3	203.634	195.419	205.704	197.4758
2	125.325	120.291	126.622	121.5571
1	42.303	40.6068	42.744	41.03424
0	0	0	0	0

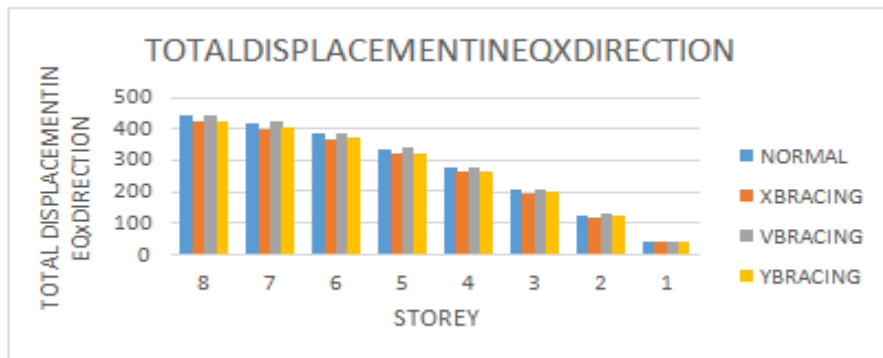

Note: Here V bracing is Inverted V bracing

**Graph 6.7 Total Displacement in EQx Direction for sand**

Above graph shows total Displacement in EQx direction for normal building, X bracing, Y bracing, inverted V bracing structure. As we can see that X bracing has the lower

Displacement than the normal, Y and inverted V bracing. X bracing has lower value than the normal, inverted V and Y bracing building by 4.12 %, 5%, 1.03%.

**B. TOTAL DISPLACEMENT IN EQy DIRECTION IN MM**

**Table 6.8**Total Displacement in EQy Direction for Sand

TOTALDISPLACEMENTINEQYDIRECTION				
STOREY	NORMAL	XBRACING	Inverted VBRACING	YBRACING
8	1247.545	1227.72	1235.782	1250
7	1196.951	1178.18	1185.863	1200
6	1101.806	1084.73	1091.758	1100
5	965.1264	950.315	956.4415	966.35
4	792.14	780.098	785.101	793.352
3	589.0794	580.218	583.9194	590.25
2	363.1688	357.784	360.0489	364.23
1	122.7429	120.931	121.6945	123.35
0	0	0	0	0

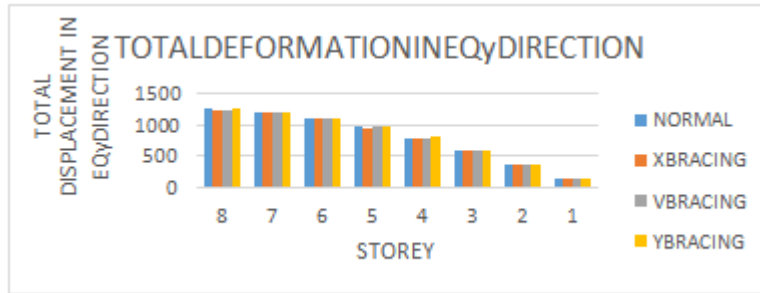

Note: Here V bracing is Inverted V bracing

**Graph 4.8 Total Displacement in EQy Direction for Sand**

**SAND**

Above graph shows total Displacement in EQy direction for normal building, X bracing, Y bracing inverted V bracing structure. As we can see that X bracing has the lower

Displacement than the normal, Y and inverted V bracing. X bracing has lower value than the normal, inverted V bracing building by 1.58 %, 0.94% resp.

**A. STORY DRIFT IN EQx DIRECTION**

**Table 6.9 Storey Drift in EQx direction for Sand**

STORY DRIFT IN EQx DIRECTION				
STOREY	NORMAL	XBRACING	Inverted VBRACING	YBRACING
8	8.14065	7.815886	8.06593	7.903
7	12.5895	12.0986	12.48566	12.236
6	17.2074	16.55	17.07946	16.738
5	21.37275	20.56423	21.22212	20.8
4	24.82935	23.89779	24.66232	24.172
3	27.43335	26.41093	27.25586	26.714
2	29.0619	27.98688	28.88223	28.308
1	29.61525	28.92	29.43431	28.85
0	0	0	0	0

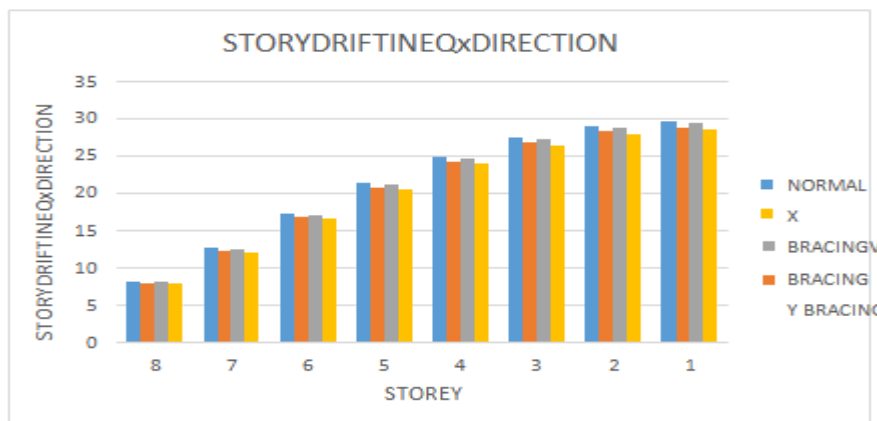

Note: Here V bracing is Inverted V bracing

**Graph 4.9 Storey Drift in EQx direction or Sand**



Above graph shows story drift in EQx direction for normal building, X bracing, Y bracing inverted V bracing structure. As we can see that X bracing has the lower story drift than

the normal, Y and inverted V bracing. X bracing has lower value than the Normal, inverted V and Y bracing by 2.70%, 2.04%, 0.34% resp.

**B. STORY DRIFT IN EQy DIRECTION**

**Table 4.10 Storey Drift in EQy direction for Sand**

STORY DRIFT IN EQy DIRECTION				
STOREY	NORMAL	XBRACING	Inverted VBRACING	YBRACING
8	17.7114	17.09	17.56356	17.65138
7	32.7831	31.722	32.58199	32.7449
6	46.5003	45.052	46.26142	46.49273
5	58.3254	56.547	58.05801	58.3483
4	68.05785	66.009	67.76782	68.10666
3	75.4488	73.2	75.14674	75.52247
2	80.16435	77.819	79.87959	80.27899
1	81.8349	79.449	81.55128	81.95904
0	0	0	0	0

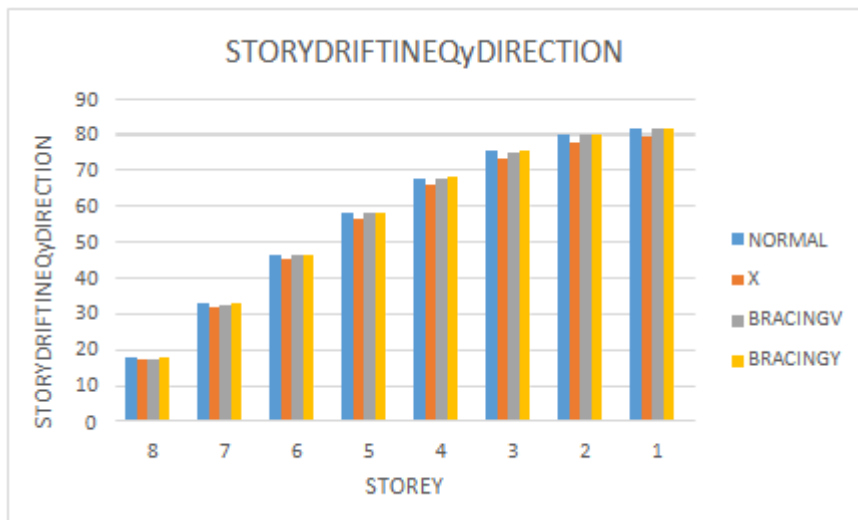

Note: Here V bracing is Inverted V bracing

**Graph 6.10 Storey Drift in EQy direction for Sand**

**SAND**

Above graph shows story drift in EQy direction for normal building, X bracing, Y bracing inverted V bracing structure. As we can see that X bracing has the lower story drift than

the normal, Y and inverted V bracing. X bracing has lower value than the normal, inverted V and Y bracing by 2.93 %, 2.57%, 3.05% resp.

**A. BASE SHEAR IN EQ<sub>x</sub> DIRECTION IN NEWTON**

**Table 4.11 Base Shear in EQ<sub>x</sub> direction for Sand**

BASE SHEAR IN EQ <sub>x</sub> DIRECTION				
STOREY	NORMAL	XBRACING	Inverted VBRACING	YBRACING
8	1638.186	1653.877	1650.758	1568.22
7	3142.182	3184.798	3176.224	3017.413
6	4465.076	4531.25	4517.905	4292.01
5	5612.479	5699.05	5681.573	5397.495
4	6560.54	6664.063	6643.152	6310.994
3	7286.878	7403.432	7379.88	7010.886
2	7764.702	7894.086	7867.914	7474.518
1	7933.738	8066.35	8039.522	7637.546
0	0	0	0	0

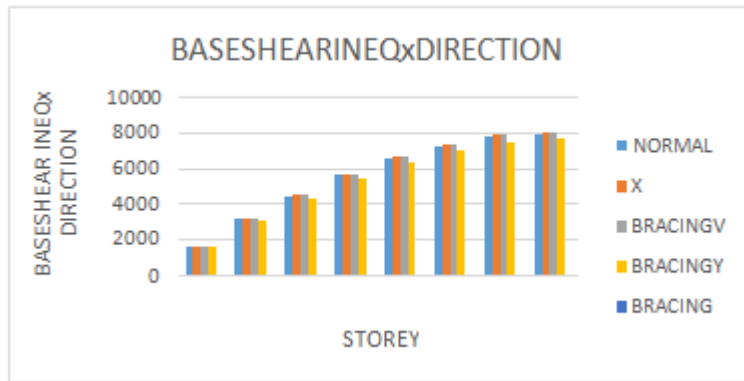

Note: Here V bracing is Inverted V bracing

**Graph 4.11 Base Shear in EQ<sub>x</sub> direction for Sand**

**SAND**

Above graph shows base shear in EQ<sub>x</sub> direction for normal building, X bracing, Y bracing inverted V bracing structure. As we can see that X bracing has the higher base shear than

the normal, Y and inverted V bracing. X bracing has higher value than the normal, inverted V and Y bracing building by 1.64%, 0.33%, 5.31% resp.

**B. BASE SHEAR IN EQ<sub>y</sub> DIRECTION IN NEWTON**

**Table 6.12 Base Shear in EQ<sub>y</sub> direction for Sand**

BASE SHEAR IN EQ <sub>y</sub> DIRECTION				
STOREY	NORMAL	XBRACING	Inverted VBRACING	YBRACING
8	1542.552	1590.099	1586.959	1507.611
7	2970.691	3074.636	3066.008	2912.708
6	4240.069	4393.99	4380.517	4161.491
5	5337.464	5534.577	5516.918	5241.072
4	6246.375	6479.311	6458.174	6135.265
3	6944.372	7204.902	7181.077	6822.023



2	7400.847	7683.673	7657.204	7274.344
1	7569.299	7858.932	7831.783	7440.194
0	0	0	0	0

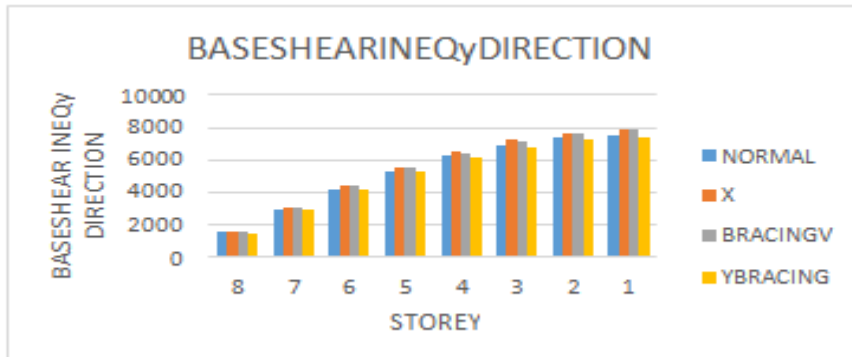

Note: Here V bracing is Inverted V bracing

**Graph 4.12 Base Shear in EQy direction for Sand**

Above graph shows base shear in EQy direction for normal building, X bracing, Y bracing inverted V bracing structure. As we can see that X bracing has the higher base shear than

the normal, Y and inverted V bracing. X bracing has higher value than the normal, inverted V and Y bracing by 3.68%, 0.346%, 5.32% resp.

**Results for Silty Soil**

**A. TOTAL DISPLACEMENT IN EQx DIRECTION IN MM**

**Table 6.13** Total Displacement in EQx Direction for Silty

TOTAL DISPLACEMENT IN EQx DIRECTION				
STOREY	NORMAL	XBRACING	Inverted VBRACING	YBRACING
8	485.2408	445.206	467.4663	454.399
7	460.4094	422.5	443.625	430.7105
6	421.7477	387.099	406.454	394.3555
5	368.4241	338.218	355.1289	344.8665
4	301.7696	277.076	290.9298	283.36
3	223.9974	205.704	215.9892	211.3815
2	137.8575	126.622	132.9531	130.801
1	46.5333	42.744	44.8812	44.3135
0	0	0	0	0

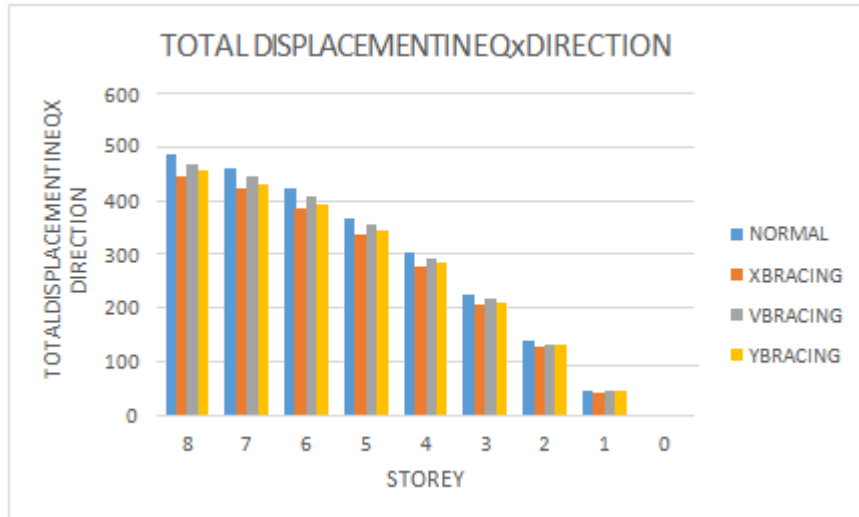

Note: Here V bracing is Inverted V bracing

**Graph 4.13** Total Displacement in EQx Direction for Silty

**SILTY**

Above graph shows total Displacement in EQx direction for normal building, X bracing, Y bracing inverted V bracing structure. As we can see that X bracing has the lower

Displacement than the normal, Y and inverted V bracing. X bracing has lower value than the normal, inverted V and Y bracing by 8.24 %, 4.74%, 6.33% resp.

**A. TOTAL DISPLACEMENT IN EQy DIRECTION IN MM**

**Table 4.14** Total Displacement in EQy Direction for Silty

TOTAL DISPLACEMENT IN EQy DIRECTION				
STOREY	NORMAL	XBRACING	Inverted VBRACING	YBRACING
8	1306.952	1203.645	1251.791	1282.016
7	1253.948	1155.075	1201.278	1226.441
6	1154.273	1063.456	1105.994	1126.776
5	1011.085	931.681	968.9482	989.748
4	829.8609	764.802	795.3941	820.097
3	617.1308	568.841	591.5946	619.7705
2	380.4625	350.769	364.7998	389.8325
1	128.5878	118.56	123.3024	133.9785
0	0	0	0	0

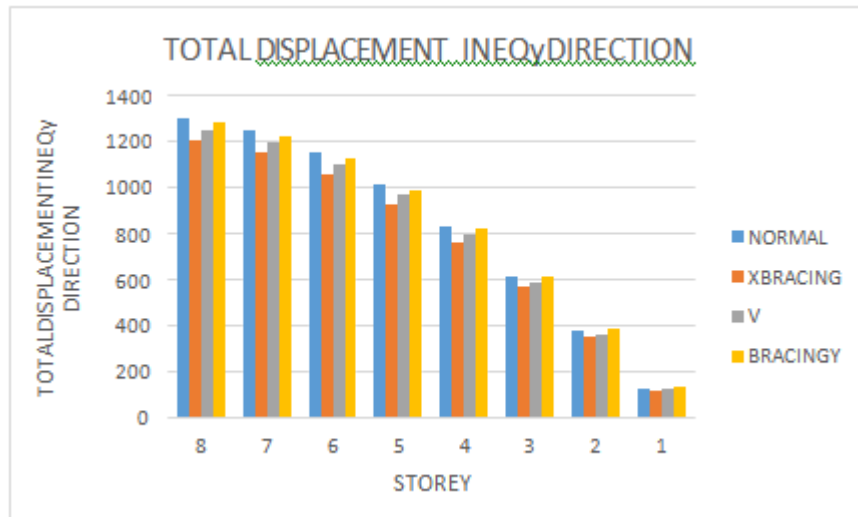

Note: Here V bracing is Inverted V bracing

**Graph 6.14** Total Displacement in EQy Direction for Silty

**SILTY**

Above graph shows total Displacement in EQy direction for normal building, X bracing, Y bracing inverted V bracing structure. As we can see that X bracing has the lower

Displacement than the normal, Y and inverted V bracing. X bracing has lower value than the normal, inverted V and bracing by 7.90 %, 3.84%, 6.11% resp.

**A. STORY DRIFT IN EQx DIRECTION**

**Table 4.15** Storey Drift in EQx direction for Silty

STORY DRIFT IN EQx DIRECTION				
STOREY	NORMAL	XBRACING	Inverted VBRACING	YBRACING
8	7.753	7.50785	8.921	8.11
7	11.99	11.6242	13.3595	12.145
6	16.388	15.9011	17.5835	15.985
5	20.355	19.315	21.2465	19.76
4	23.647	22.155	24.3705	22.9
3	26.127	24.515	26.9665	25.37
2	27.678	26.22	28.842	26.89
1	28.205	26.86	29.546	27.40

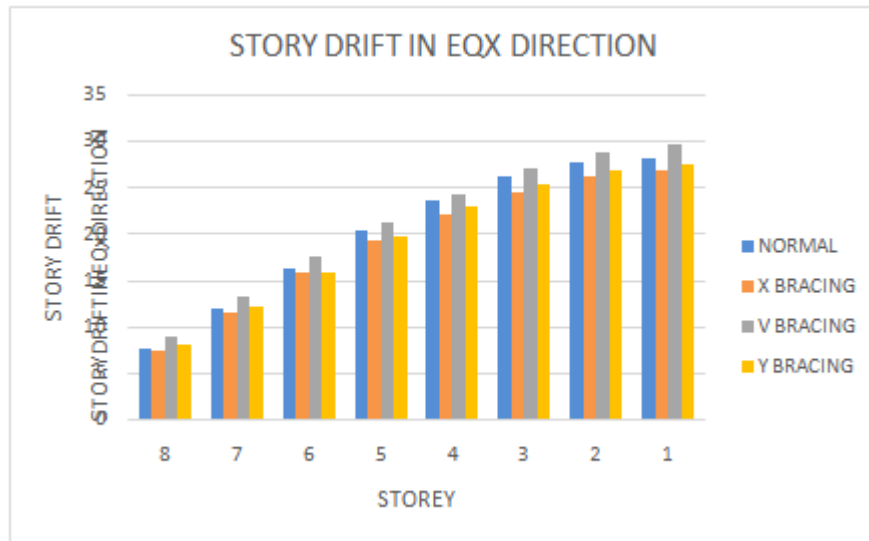

Note: Here V bracing is Inverted V bracing

**Graph 4.15 Storey Drift in EQx direction for Silty**

**SILTY**

Above graph shows story drift in EQx direction for normal building, X bracing, Y bracing, inverted V bracing structure. As we can see that X bracing has the lower story drift than

the normal, Y and inverted V bracing. X bracing has lower value than the normal, inverted V bracing, Y bracing building by 4.96 %, 9.15%, 2.19 resp.

**B. STORY DRIFT IN EQy DIRECTION**

**Table 4.16 Storey Drift in EQy direction for Silty**

STORY DRIFT IN EQY DIRECTION				
STOREY	NORMAL	XBRACING	Inverted VBRACING	YBRACING
8	21.5067	17.771	20.505	17.853
7	39.80805	29.484	34.02	31.722
6	56.46465	37.5765	43.3575	45.052
5	70.8237	43.4785	50.1675	56.547
4	82.64168	48.6135	56.0925	66.009
3	91.6164	53.7875	62.0625	73.2
2	97.34243	58.773	67.815	77.819
1	99.37095	61.4185	70.8675	79.449

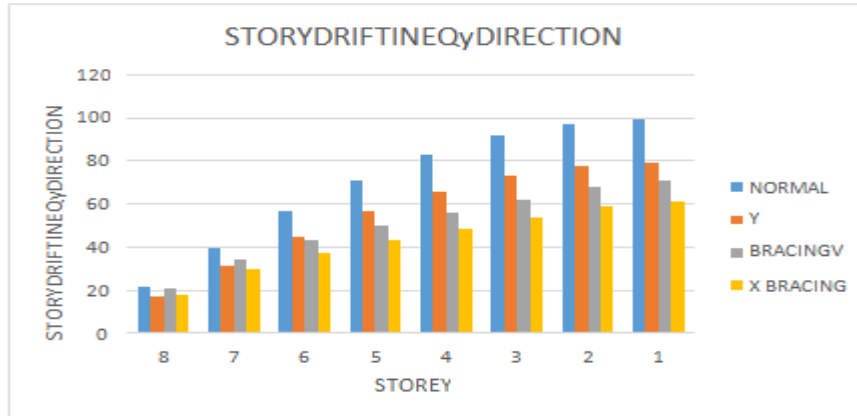

**Graph 4.16 Storey Drift in EQy direction for Silty**

**SILTY**

Above graph shows story drift in EQy direction for normal building, X bracing, Y bracing, inverted V bracing structure. As we can see that X bracing has the lower story drift than

the normal, Y and inverted V bracing. X bracing has lower value than the normal, inverted V and Y bracing building by 38.16 %, 13.33%, 22.69% resp.

**A. BASE SHEARIN EQx DIRECTION IN NEWTON**

**Table 4.17 Base Shear in EQx direction for Silty**

BASE SHEAR IN EQx DIRECTION				
STOREY	NORMAL	XBRACING	Inverted VBRACING	YBRACING
8	1638.186	1686.954	1518.259	1487.636
7	3142.182	3248.494	2923.645	2667.684
6	4465.076	4621.875	4159.688	3562.208
5	5612.479	5813.031	5231.728	4303.732
4	6560.54	6797.344	6117.61	4934.46
3	7286.878	7551.5	6796.35	5481.087
2	7764.702	8051.968	7246.771	5928.312
1	7933.738	8227.677	7404.909	6440.282
0	0	0	0	0

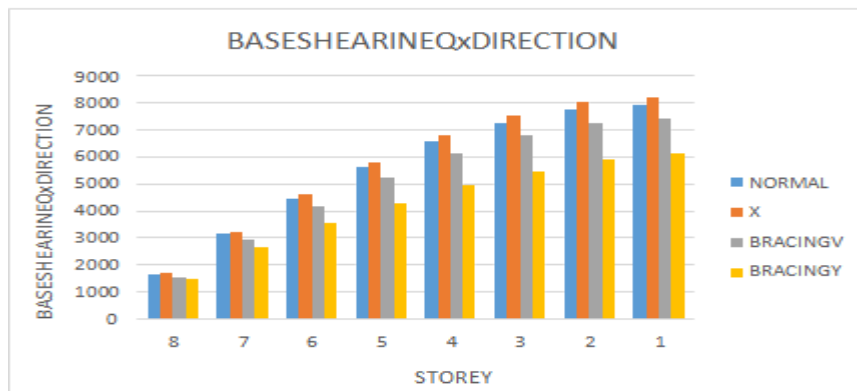

Note: Here V bracing is Inverted V bracing

**Graph 4.17 Base Shear in EQx direction for Silty**

**SILTY**

Above graph shows base shear in EQx direction for normal building, X bracing, Y bracing inverted V bracing structure. As we can see that X bracing has the higher base shear than

the normal, Y and inverted V bracing. X bracing has higher value than the normal, inverted V and Y bracing building by 3.57%, 9.59% and 21.72% resp.

**B. BASE SHEAR IN EQy DIRECTION IN NEWTON**

**Table 4.18 Base Shear in EQy direction for Silty**

BASE SHEAR IN EQy DIRECTION				
STOREY	NORMAL	XBRACING	Inverted VBRACING	YBRACING
8	1623.739	1655.67	1490.103	1397.521
7	3127.043	3201.425	2881.283	2333.345
6	4463.23	4575.185	4117.667	2951.969
5	5618.383	5762.807	5186.526	3404.545
4	6575.131	6746.499	6071.849	3805.213
3	7309.865	7502.011	6751.81	4215.755
2	7790.366	8000.525	7200.473	4624.801
1	7967.683	8183.011	7364.71	4866.087
0	0	0	0	0

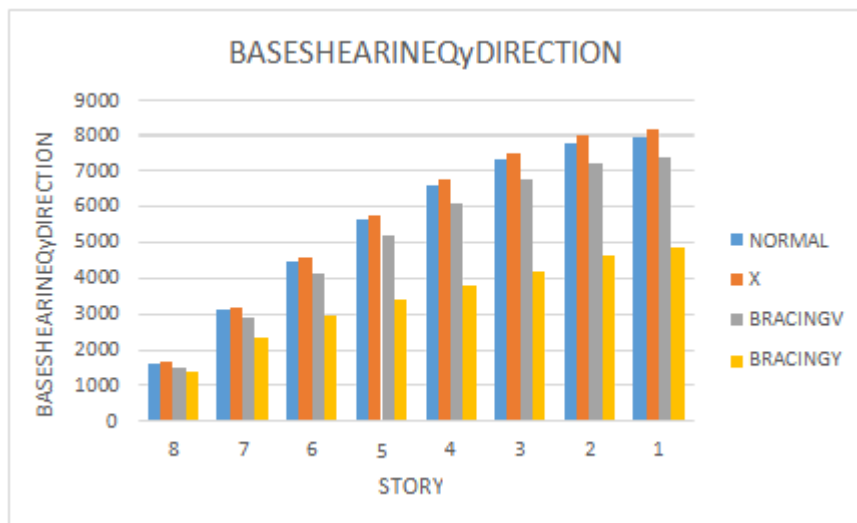

Note: Here V bracing is Inverted V bracing

**Graph 4.18 Base Shear in EQy direction for Silty**

**SILTY**

Above graph shows base shear in EQy direction for normal building, X bracing, Y bracing, inverted V bracing structure. As we can see that X bracing has the higher base shear than

the normal, Y and inverted V bracing. X bracing has higher value than the normal and inverted V bracing building by 2.63%, 10% resp.

**6.2 COMPARISON OF CLAY, SANDY AND SILTY SOIL FOR WITH AND WITHOUT SSI FOR X BRACING**

DISPLACEMENT IN EQ <sub>x</sub> DIRECTION						
STOREY	CLAY		SAND		SILTY	
	WITHOUT SSI	WITH SSI	WITHOUT SSI	WITH SSI	WITHOUT SSI	WITH SSI
8	422.9495	359.122	422.946	291.222	445.206	226.873
7	401.4026	336.501	401.375	272.981	422.5	212.588
6	367.7593	301.533	367.744	244.728	387.099	190.572
5	321.3223	253.9	321.307	206.192	338.218	160.566
4	263.2346	188.019	263.222	158.89	277.076	123.755
3	195.4283	124.843	195.419	105.635	205.704	82.328
2	120.2976	60.821	120.291	51.596	126.622	40.297
1	40.60965	9.969	40.6068	8.547	42.744	6.795
0	0	0.213	0	0.179	0	0.178

**Table 4.19 Displacement in EQ<sub>x</sub> direction with and without SSI**



**Fig 4.4 Displacement in EQ<sub>x</sub> direction with SSI for clay soil with X bracing**

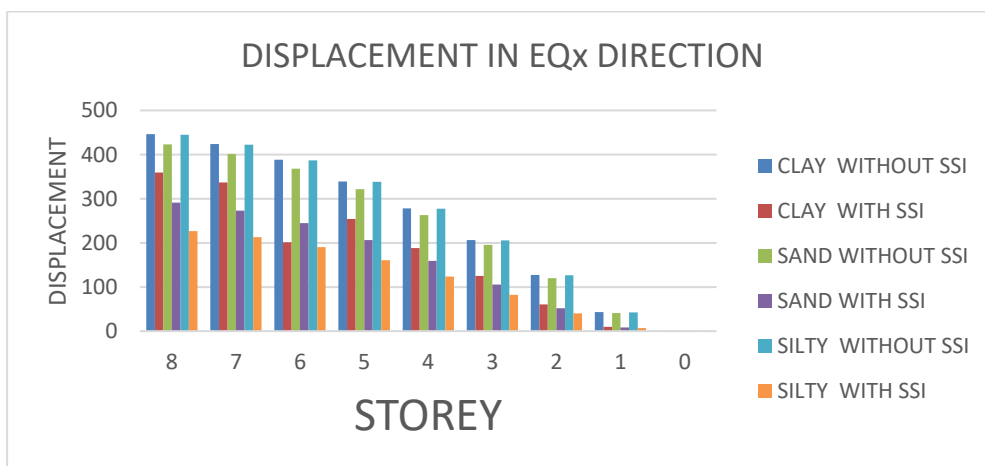

**Graph 4.19 Displacement in EQ<sub>x</sub> direction with and without SSI**



The above graphs show total Displacement in EQ<sub>x</sub> direction for clay, sandy and silty soil for with and without SSI structure. In clay with SSI has lower Displacement than the without SSI structure by 18.39%. In sandy soil with SSI

has lower Displacement than the without SSI structure by 31.14 %. In silty soil with SSI has lower Displacement that the without SSI structure by 49.01%.

**DISPLACEMENT IN EQ<sub>y</sub> DIRECTION**

**Table 4.20** Displacement in EQ<sub>y</sub> direction with and without SSI

DISPLACEMENT IN EQ <sub>y</sub> DIRECTION						
	CLAY		SAND		SILTY	
STOREY	WITHOUT SSI	WITH SSI	WITHOUT SSI	WITH SSI	WITHOUT SSI	WITH SSI
8	490.125	400.236	1227.7179	789.429	1203.645	673.428
7	488.639	480.369	1178.1765	753.221	1155.075	642.825
6	395.236	390.365	1084.72512	685.871	1063.456	585.591
5	341.258	344.253	950.31462	589.642	931.681	503.75
4	285.236	285.659	780.09804	468.58	764.802	400.743
3	240.285	245.263	580.21782	327.601	568.841	280.718
2	190.036	190.236	357.78438	173.148	350.769	148.97
1	92.152	90.126	120.9312	24.887	118.56	21.241
0	0		0	0.169	0	0.17

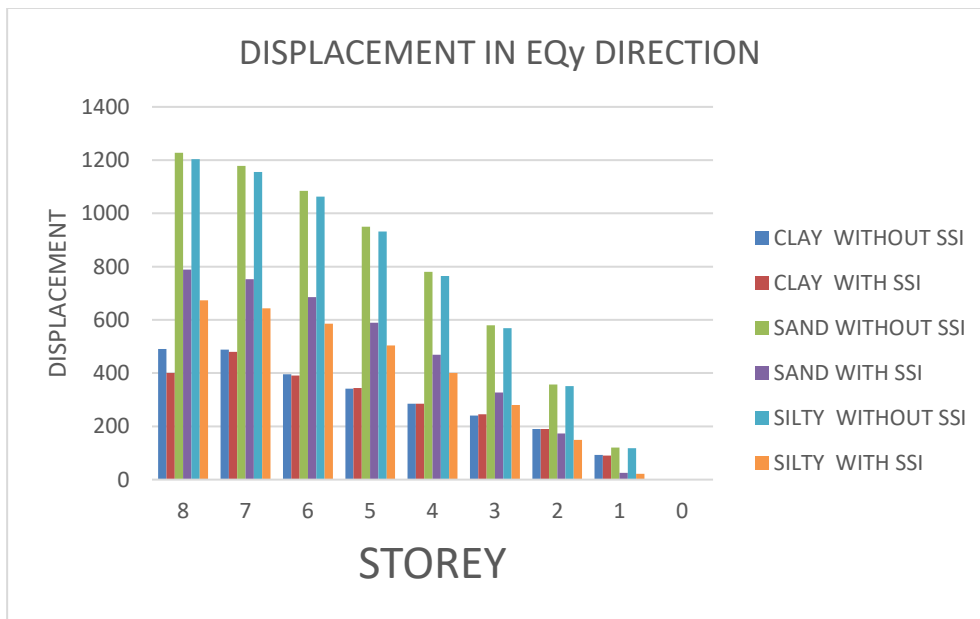

**Graph 4.20** Displacement in EQ<sub>y</sub> direction with and without SSI

The above graphs show total Displacement in EQ<sub>y</sub> direction for clay, sandy and silty soil for with and without SSI structure. In clay with SSI has lower Displacement than the without SSI structure by 18.34%. In sandy soil with SSI

has lower Displacement than the without SSI structure by 35.64 %. In silty soil with SSI has lower Displacement than the without SSI structure by 44.05 %.

**STORY DRIFT IN EQ<sub>x</sub> DIRECTION**

**Table 4.21 Storey drift in EQ<sub>x</sub> direction with and without SSI**

STORY DRIFT IN EQ <sub>x</sub> DIRECTION						
	CLAY		SAND		SILTY	
STOREY	WITHOUT SSI	WITH SSI	WITHOUT SSI	WITH SSI	WITHOUT SSI	WITH SSI
8	7.894	7.7	7.903	6.341	7.50785	4.965
7	12.234	11.9	12.236	9.741	11.6242	7.596
6	16.739	16.0	16.738	13.164	15.9011	10.252
5	20.8	19.065	20.8	16.057	19.76	12.498
4	24.173	21.371	24.172	18.008	22.9634	14.012
3	26.715	21.619	26.714	18.241	25.3783	14.191
2	28.309	17.169	28.308	14.529	26.8926	11.312
1	28.85	6.586	28.85	5.646	27.4075	4.466

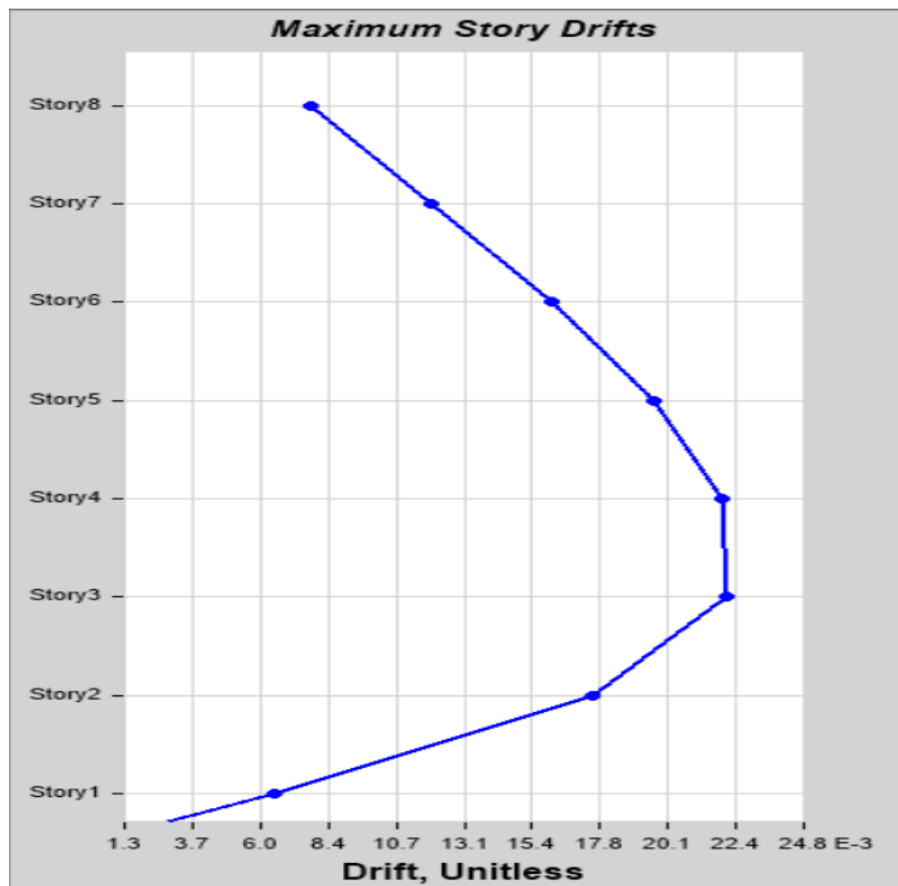

**Fig 4.5 Storey drift in EQ<sub>x</sub> direction with SSI for clay soil with X bracing**

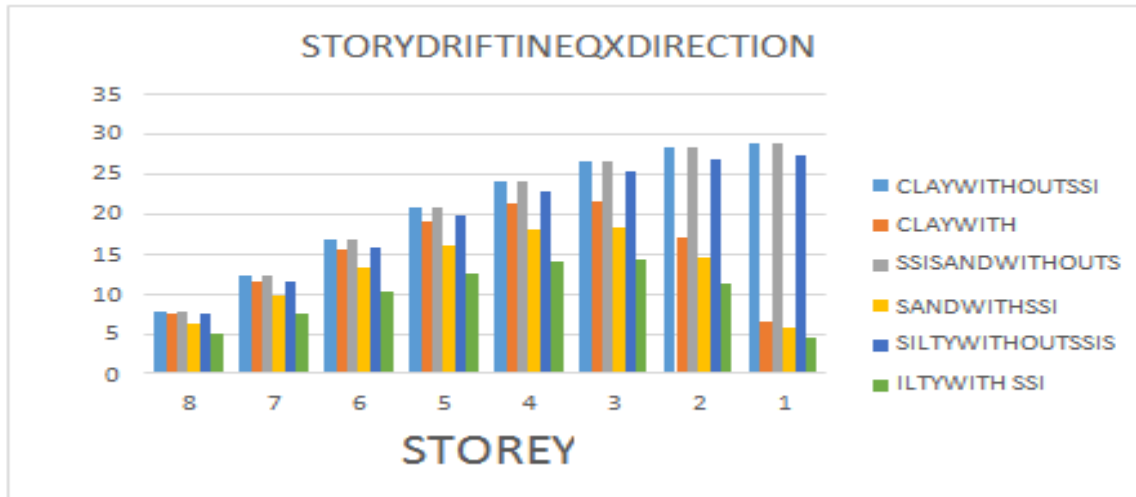

**Graph 4.21** Storey drift in EQx direction with and without SSI

The above graphs show total story drift in EQx direction for clay, sandy and silty soil for with and without SSI structure. In clay with SSI has lower story drift that the without SSI structure by 3.84 %. In sandy soil with SSI has lower story

drift that the without SSI structure by 20.25 %. In silty soil with SSI has lower story drift that the without SSI structure by 37.17 %.

**STORY DRIFT IN EQy DIRECTION**

**Table 4.22** Storey drift in EQy direction with and without SSI

STORY DRIFT IN EQy DIRECTION						
STOREY	CLAY		SAND		SILTY	
	WITHOUT SSI	WITH SSI	WITHOUT SSI	WITH SSI	WITHOUT SSI	WITH SSI
8	17.091	16.308	17.09	12.692	17.771	10.727
7	31.722	30.103	31.722	23.256	29.484	19.761
6	45.054	42.547	45.052	32.827	37.5765	27.911
5	56.548	53.11	56.547	40.948	43.4785	34.829
4	66.011	61.554	66.009	47.424	48.6135	40.36
3	73.202	67.353	73.2	51.794	53.7875	44.16
2	77.821	65.191	77.819	49.636	58.771	42.751
1	79.451	21.388	79.449	16.561	61.4185	14.111

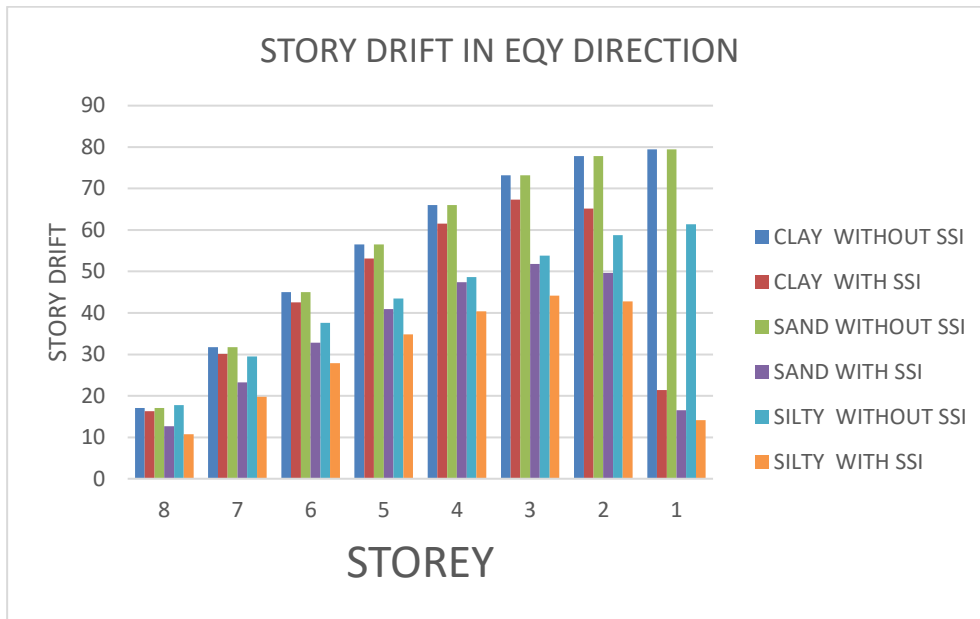

**Graph 4.22 Storey drift in EQy direction with and without SSI**

The above graphs show total story drift in EQY direction for clay, sandy and silty soil for with and without SSI structure. In clay with SSI has lower story drift that the without SSI structure by 4.58 %.

In sandy soil with SSI has lower story drift that the without SSI structure by 25.73%. In silty soil with SSI has lower story drift that the without SSI structure by 39.63%.

**BASE SHEAR IN EQx DIRECTION**

**Table 4.23 Base shear in EQx direction with and without SSI**

BASE SHEAR IN EQx DIRECTION						
STOREY	CLAY		SAND		SILTY	
	WITHOUT SSI	WITH SSI	WITHOUT SSI	WITH SSI	WITHOUT SSI	WITH SSI
8	1676.5633	1660.632	1653.8769	1663.5234	1686.954438	1705.881966
7	3345.55809	3143.898	3184.7981	3256.254	3248.494062	3250.236
6	4707.33869	4418.318	4531.2501	4652.352	4621.875102	4751.652
5	5854.781	5954.761	5699.0503	5746.234	5813.031306	5913.23
4	6754.74933	6784.7495	6664.0627	6754.214	6797.343954	6895.325
3	7599.24234	7688.245	7403.4316	7435.234	7551.500232	7166.683608
2	7593.3454	7693.5698	7894.0859	7900.235	8051.967618	8165.23
1	8163.06678	8265.3698	8066.3499	8165.123	8227.676898	8322.654

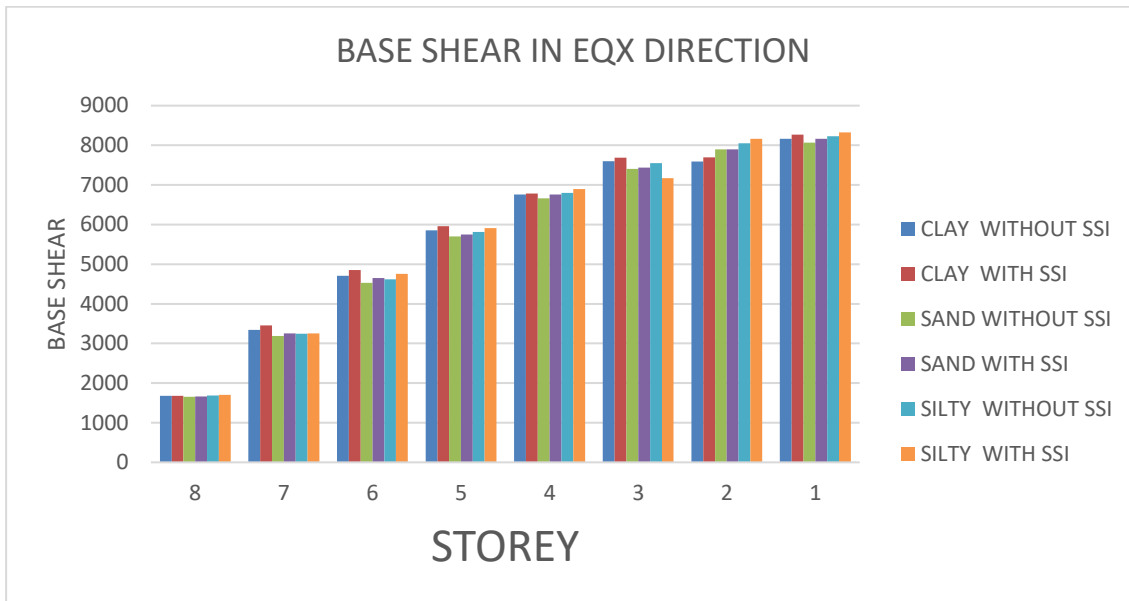

**Graph 4.23** Base Shear in EQx direction with and without SSI

The above graphs show base shear in EQx direction for clay, sandy and silty soil for with and without SSI structure. In clay with SSI has higher base shear than the without SSI structure by 1.23 %. In sandy soil with SSI has

higher base shear than the without SSI structure by 1.20 % in silty soil with SSI has higher base shear than the without SSI structure by 1.14 %.

**BASE SHEAR IN EQY DIRECTION**

**Table 4.24** Base Shear in EQy direction with and without SSI

BASE SHEAR IN EQy DIRECTION						
STOREY	CLAY		SAND		SILTY	
	WITHOUT SSI	WITH SSI	WITHOUT SSI	WITH SSI	WITHOUT SSI	WITH SSI
8	1606.494792	1632.8406	1590.099175	1634.2204	1655.670275	1666.354
7	3106.334126	3149.8345	3074.635966	3149.2394	3201.425078	3211.869228
6	4439.28926	4483.9252	4393.989905	4481.0683	4575.185365	4598.256
5	5591.635098	5619.5658	5534.577112	5614.1877	5762.807096	5789.325
4	6546.107666	6549.2354	6479.310552	6528.2956	6746.498616	6789.354
3	7279.179026	7280.123	7204.90198	7352.254	7502.01134	7536.254
2	7762.885956	777.254	7683.672834	7698.214	8000.525322	8026.325
1	7939.950004	7995.254	7858.931755	7869.542	8183.011415	8283.235

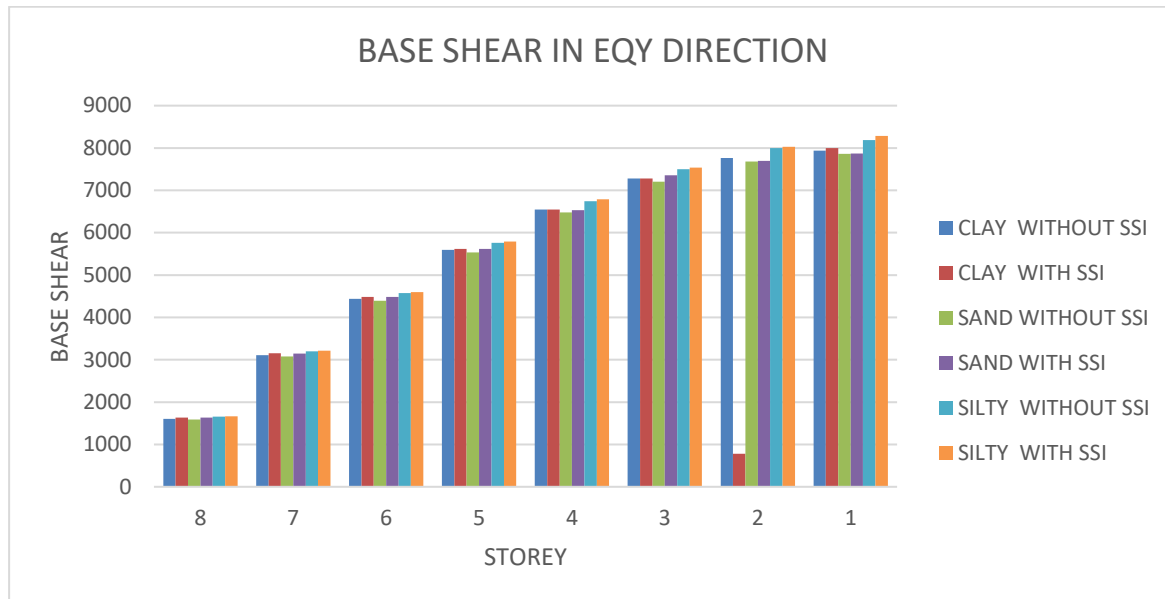

**Graph 4.24 Base Shear in EQy direction with and without SSI**

The above graphs show base shear in EQy direction for clay, sandy and silty soil for with and without SSI structure. In clay with SSI has higher base shear than the without SSI structure by 1.613%. In sandy soil with SSI has higher base shear than the without SSI structure by 2.699% in silty soil with SSI has higher base shear than the without SSI structure by 0.567%.

## VI. CONCLUSION

General: It can be seen that when soil structure interaction is taken into account, the true design values arrived-at may be quite different from those worked out without considering interaction. SSI is more beneficial to evaluate effects of seismic ground motion of the structure.

- Displacement for X bracing is lesser than the without bracing, Y bracing and inverted V bracing in each soil. In X, Y and V bracing X bracing has the lesser Displacement than the other two. As X bracing has less displacement it limits the building's lateral movement and keep building stable during seismic events.
- In silty soil, X bracing has lower value of displacement than the normal bracing as well as V bracing and Y bracing by 8.24%, 4.74%, 6.33% resp.
- Storey drift for X bracing is lesser than the normal, Y and V bracing. In X, Y and V bracing X bracing has the lower Storey drift than the other two. As X bracing has less storey displacement it limits deflection between two adjacent stories.
- In silty soil, X bracing has lower value of story drift than the normal bracing as well as V bracing building by 4.96%, 9.15%, 2.19 resp.
- Base shear for X bracing is greater than the normal, Y and V bracing. In X, Y and V bracing X bracing has the

higher base shear than the other two. As the X bracing has higher base shear so the building can take lateral load or load due to the earthquake, it will increase the stability of structure.

- In silty soil, X bracing has higher value of base shear than the normal bracing as well as V and Y bracing building by 3.57%, 9.59% and 21.72% resp.
- Displacement for clay, sand, and silty is lesser with SSI compare to without SSI.
- Story drift for clay, sand, and silty is lesser with SSI compare to without SSI.
- Base shear for clay, sand and silty is higher with SSI compare to without SSI.

## VII. LIMITATIONS:

- In my study, I have used response spectrum analysis.
- There are different types of bracings, but in my study I have used three types of bracings i.e X bracing, Y bracing and inverted V bracing.
- In my study I have used three types of soil conditions for analysis i.e clay, silt and sand.

## VIII. REFERENCES

- [1]. Antonios Flogeras et.al. "On the seismic response of steel buckling-restrained braced structures including soil-structure interaction" Vol. 12, No. 4 (2017) <sup>[1]</sup>
- [2]. F. Barbagallo et.al. "Seismic design and performance of dual structures with BRBs and semi-rigid connections" Accepted 31 March 2019. <sup>[2]</sup>
- [3]. Héctor Guerreroa, et.al. "Experimental damping on frame structures equipped with buckling-restrained braces (BRBs) working within their linear-elastic



- response. Soil” dynamics and earthquake engineering 2017. <sup>[3]</sup>
- [4]. HamdyAbou-Elfath et.al. “Periods of BRB steel buildings designed with variable seismic-force demands” Accepted 11 February 2019. <sup>[4]</sup>
- [5]. Hendrik Wijaya et.al. “Department of Infrastructure Engineering, University of Melbourne” VIC 3010, Australia. Accepted 12 February 2019.<sup>[5]</sup>
- [6]. Jose A. Sy et.al. “Application of Buckling Restrained Braces in a 50-Storey Building” 2014. <sup>[6]</sup>
- [7]. Shuling Hua et.al. “Seismic evaluation of low-rise steel building frames with self-centering energy-absorbing rigid cores designed using a force-based approach”. <sup>[7]</sup>
- [8]. S.A. SeyedRazzaghi “Evaluating the Performance of the Buckling Restrained Braces in Tall Buildings with peripherally Braced Frames.”*Journal of Rehabilitation in Civil Engineering* 7-2 (2019) 21-39 05 February 2018. <sup>[8]</sup>
- [9]. YingZhou\*,PengChen Shaking table tests and numerical studies on the effect of viscous dampers on an isolated RC building by friction pendulum bearings. <sup>[9]</sup>
- [10]. Yi Min Wu, BijanSamali on Shake table testing of a base isolated model. <sup>[10]</sup>
- [11]. Zhiying Zhang, Hongyang Wei, Xin Qin Experimental study on damping characteristics of soil-structure interaction system based on shaking table test [2017]. <sup>[11]</sup>
- [12]. ZhuangHaiyanga,n, Yu Xub,a, Zhu Chaoa, JinDandana Shaking table tests for the seismic response of a base-isolated structure with the SSI effect [2019]. <sup>[12]</sup>
- [13]. IS Code 1893:2016.
- [14]. Principle of Geotechnical Engineering, 8<sup>th</sup> Edition, SI. Braja M. Das and Khaled Sobhan Publisher, global engineering.

# IJEAST

INTERNATIONAL JOURNAL  
OF ENGINEERING APPLIED SCIENCE  
AND TECHNOLOGY

## ABOUT IJEAST

International Journal of Engineering Applied Science and Technology (IJEAST) is a peer-reviewed, open access journal that publishes high-quality research papers in the field of Engineering, Applied Science and Technology.

IJEAST aims to provide a platform for researchers, academicians, and professionals to share their innovative ideas, research findings, and practical experiences with the global scientific community.

## FOCUS AREAS

- Engineering
- Applied Science
- Technology
- Innovation & Development
- Interdisciplinary Studies



### PEER REVIEWED

All submissions are rigorously peer reviewed to ensure quality.



### OPEN ACCESS

Free and unrestricted access to research for all.



### GLOBAL REACH

Connecting researchers and professionals worldwide.



### TIMELY PUBLICATION

We ensure a swift and efficient publication process.



For more information, visit our website

[www.ijeast.com](http://www.ijeast.com)



INTERNATIONAL JOURNAL  
OF ENGINEERING APPLIED SCIENCE  
AND TECHNOLOGY

✉ [editor@ijeast.com](mailto:editor@ijeast.com)

🌐 [www.ijeast.com](http://www.ijeast.com)

📍 India



2455-2143