



IJEAST

INTERNATIONAL JOURNAL
OF ENGINEERING APPLIED SCIENCE
AND TECHNOLOGY



VOLUME : 6 ISSUE : 6 Print / Issue Publication Date: 10-Jan-2022



ISSN : 2455-2143



DOI : 10.33564/IJEAST.2021.v06i06.032

Indexed In



WWW.IJEAST.COM

editor@ijeast.com



DESIGN AND FABRICATION OF A COMPACT MULTI – OPERATED MANHOLE CLEANING MACHINE

Mithun S

Department of Mechanical Engineering
AMC Engineering College, Bangalore, Karnataka, India

Pramukh M

Department of Mechanical Engineering
AMC Engineering College, Bangalore, Karnataka, India

Abstract— Water drainage systems undergoing rapid flooding pose a serious threat to public safety, traffic and present a variety of operational problems. The serious repercussions of the current design of manholes put an operator's life at great risk i.e., during the overflow and displacement of manhole covers, during cleaning and maintenance of manholes. Manholes provide a variety of dangers for those who work within them. Impurities in drainage water viz., excreta, empty bottles, polythene bags, papers, etc. result in aggravation and blockage of the sewer system. Toxic gases resulting from the waste accumulated may build up in areas of the sewer, rising to levels that constitute severe risks to those breathing them. There have also been considerably fewer and slower advancements in the development of machines for the dedicated purpose of manhole cleaning. The machines that are currently in use serve the purpose but come with the restraints of high capital and expenditures. Another drawback being that these machines are bulky in size which becomes difficult in handling and transportation. Our project is aimed at eradicating manual human scavenging of the waste accumulated inside the manholes[1]. We are aiming at cleaning the manholes efficiently and economically using our machine. Through this project, we aim to eliminate the practice of humans entering the manhole physically to clean and collect the waste. We are concentrating on using a TWIST mechanism to open and close the buckets. The machines that are in use now require skilled laborers while our machine can be easily operated. We are intending to target rural areas where it becomes difficult in investing in the present automated machines which are expensive.

Keywords— Drainage systems, Manholes

I. INTRODUCTION

A manhole is an opening through which a man may enter a sewer for inspection, cleaning, and other maintenance and is fitted with a removable cover to withstand traffic loads. The manholes are first constructed and then the sewers are laid interconnecting these manholes. The manholes usually consist of a chamber or ring or a vertical circular pipe of varying sizes and depths which is used to access inspection points. Manholes are generally constructed where there is a change of direction or a change in gradient of the utilities or where access is required for a specific maintenance purpose. The top cover of the manhole protects the manhole and prevents public access. The previous designs of manholes were fitted with steps on the inside of the wall for easy access. A step ladder provided if the depth of the manhole is less than 1m and a regular ladder is fitted if the depth exceeds 2.5m.

1.1 PROBLEMS ENCOUNTERED IN THE PRESENT MANHOLE CLEANING METHODS

The current designs of manholes are overflowing with problems where due to lack of emergency response, dearth of basic safety measures and equipment lead to callous environments. With an intention to reduce labor costs and manpower costs, contractors do not take the necessary safety measures and provide facilities such as ventilators, gas concentration detectors, gloves, face masks, and hard hats under the pretext of fast-tracking tasks. The consequences of which result in the exposure of workers to three dangerous environments conspiring together: chemical, biological, and legal. These gaseous products are commonly collected under the term 'sewer gas'. According to the Wisconsin Department of Health Services, "Sewer gas is a complex mixture of toxic and non-toxic gases that can be present at varying levels depending upon the source" [4].

Drains contain abundant organic matter. Depending on the conditions of the sludge i.e., if the prevalent conditions are warm and the sludge has been stagnated, it leads to the production of Hydrogen sulphide during the decomposition of organic matter. Hydrogen sulphide is soluble in water and gets confined in sewage matter. Inhalation of this poisonous gas can result in nauseating conditions, delirium and convulsions,

which can endanger self-rescue. It also results in skin and eye irritation and pulmonary edema when inhaled through the lungs. If it is present in the sludge at 1mg per liter or more, it can accumulate in the air at hundreds of parts per million and knock a person out. The most common systems of infections among drainage workers include watery diarrhea, nausea, fever, jaundice, and typhoid. Uncommon, but nonetheless dangerous, effects include hemolytic uremic syndrome, paralysis, and kidney failure[3].

1.2 THE MACHINE - IDEA

The machine that we are designing uses a TWIST mechanism using pipes. This requires a worker to insert the pipe into the manhole and to twist it to open and close the buckets. This part is the HEART of our machine. This machine can also be driven using battery/ electricity to insert the bucket into the manhole, to open to close and remove the waste collected successfully. By doing so, we intend to make the project to be semi-automatic as well [2].

The machine has buckets designed in such a way that it can collect as much waste as possible when it is inserted into the manhole. The linear arm of the machine that goes inside the manhole will constantly be in contact with water, hence we are making it water-resistant (galvanizing) so as to protect the material from getting corroded.

The machine is mounted on a trolley with the help of a square tube chassis which acts as a trailer that can be taken to the site where cleaning of the manhole has to be conducted. The trolley/trailer is designed in such a way that the frame on which the pipe (linear arm) with the bucket is mounted can be hinged making the entire equipment easy to transport. The trailer is also designed to house a collection tank at the rear while the frame is designed to swivel around such that the waste collected can be dumped into the tank. The square frame (chassis) that is provided houses the motor, gearbox, idlers, and the panel box (contains switch controls) which are required to move the pipe and bucket into the manhole and out of it.

II. MATERIALS AND METHODOLOGY

2.1 MATERIALS

2.1.1 Circular and square pipes



A combination of both circular and square pipes has been used in our project for various parts. The manual part of our project has been completely fabricated using circular pipes. While the semi-automatic part of our project has a combination of both square and circular pipes. The square pipe has been used mainly for the vertical movement in the machine to whose one end, the buckets have been attached and actuator to the other end. The square pipe has also been used for the fabrication of the

trolley/trailer. While the circular pipe in the semi-automated machine has been used for providing support to the frame and also acts as a hinge.

2.1.2 Mild Steel (MS) Sheets

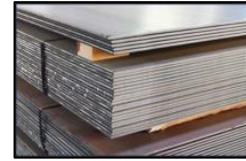

IS_2062_E250A sheets have been used majorly in our manual and semi-automated projects. The buckets in the manual machine, as well as the semi-automated machine, have been made using MS sheets. The MS sheets have been used keeping in mind the cost-effectiveness of our project. We have used MS sheets of different thicknesses in various parts in our project

2.1.3 AC Single phase motor



The single-phase AC motor has been used in our semi-automated project. We have added a couple of extra capacitors to the motor to increase its load lifting capacity. We are using a 230V 1/6th HP 1400 rpm motor.

2.1.4 Gearbox



According to our calculations, we have used a 1:100 gearbox to obtain the required torque and also to achieve the required speed reduction.

2.1.5 Sprockets



We have used 3½ inch sprockets, which help in the vertical movement. Out of the three sprockets that we have used, two act as idlers or driven, and the main sprockets attached to the gearbox shaft acts as the driver. The three sprockets are connected via a ½ inch chain.

2.1.6 Chain

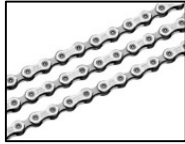

We have used ½ inch cycle chain which drives the pipe up and down when actuated by the motor via the sprockets. The total length of the chain that we have used is about 2 meters.

2.1.7 Actuator



We have used a DC actuator that has a stroke of 100mm. The actuator is mounted on the top of the square pipe and is connected to the buckets via wire ropes and help in opening and closing the bucket via a mechanism that we have previously used in our manual project

2.1.8 Switched-mode power supply (SMPS)



The actuator is run/operated using the SMPS. The specifications of the power supply being: 24V and 2 amps.

2.1.9 Relays



We have used 2 relays in order to switch between the circuits (up and down movement of the bucket). These relays are coupled with the motor and the limit switches. The specifications of the relays being: 230V and 16A Single Phase.

2.1.10 Limit switches



We have used 2 limit switches which are controlled via the relay. The limit switches in our project have been used to stop the bucket and the pipe carrying it after a certain point. The limit switches break the circuit once they are activated and close the circuit once they are deactivated.

2.1.11 DPDT Switch



The Double Pole Double Throw switch has 2 inputs and 4 outputs i.e., each input has 2 outputs. We have used the DPDT switch in our semi-automated project in order to operate the bucket (to open and close). It has ON-OFF-ON positions.

2.1.12 TPDT Switch

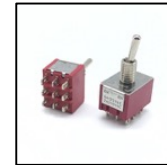

The Triple Pole Dual Throw acts just like a 2 – way switch in a 3 phase circuit. It is used to connect 2 different circuits. The TPDT switch operates the motor in the forward and backward directions which in turn moves the bucket and the pipe attached to it in the up and down direction. It has ON-OFF-ON positions.

2.1.13 Rubber tyres



We have used 4 rubber tyres for our machine which helps the entire machine (chassis) to be transported easily.

2.2 METHODOLOGY

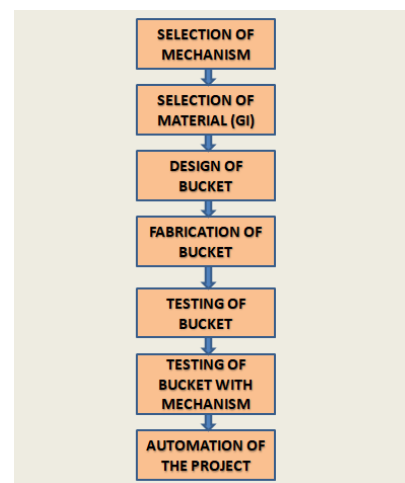

Fig 1:Flowchart of methodology

The methodology that we are following is as follows:

- The first step being the selection of the mechanism, In order to open and close the buckets we are implementing a twist mechanism.
- After selecting the mechanism the material that is suitable for this purpose is selected. For our project, the material being used is Galvanized Mild Steel.
- After the selection of the material, the bucket is designed, where the calculations are carried out regarding the volume, the weight that can be carried etc.
- The next step is the fabrication of the bucket. The bucket is fabricated according to the calculations made.
- After the fabrication, the bucket is subjected to testing where it is put into the actual use of inserting it into the manhole and collecting the waste in the given conditions.
- The bucket is then mounted on the mechanism and tested as to how efficiently it works along with the mechanism.
- In the semi-automatic part of our project, we are using AC motors, gearbox, and sprockets to perform the vertical motion and an actuator to perform the opening and closing action.

2.3 CAED MODELLING AND OUTCOME

2.3.1 CAED DRAWINGS AND OUTCOME OF LINEAR ARM OF ASSEMBLY

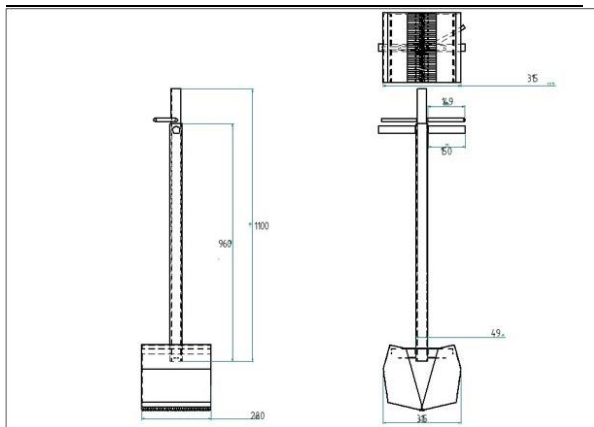

Fig 2: CAED drawing of Linear arm of Assembly

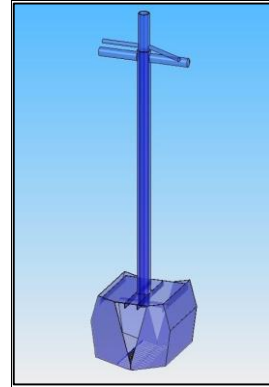

Fig 3: CAED outcome of Linear arm of Assembly

Fig 4: Outcome of Linear arm of assembly



Fig 5: Outcome of bucket of linear arm (View 1)

Fig 6: Outcome of bucket of linear arm (View 2)

2.3.2 CAED DRAWINGS OF FINISHED MODEL

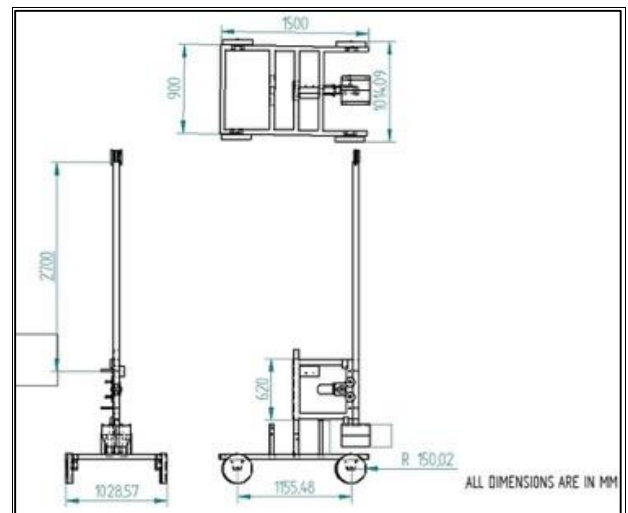

Fig 7: CAED drawing of finished model

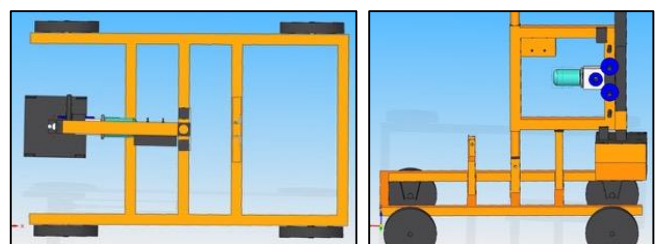

Fig 8,9: CAED outcome of finished model (Views 1&2)



Fig 10,11,12: CAED outcome of finished model (Views 3, 4 & 5)

2.3.3 WIRING DIAGRAMS

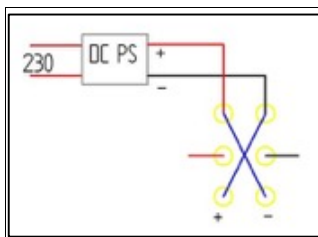

Fig 13: Actuator wiring

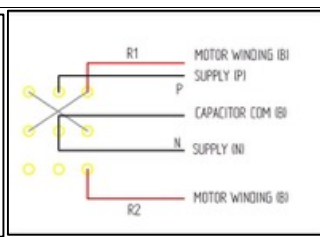

Fig 14: Motor wiring



Fig 19, 20, 21: Outcome of final model (Views 3,4 & 5)



2.4 WORKING PROCEDURE

In the semi-automatic manhole cleaning machine, the trolley/trailer is taken to the site where the manhole cleaning has to be done. The front end of the trolley/trailer is positioned such that the bucket enters the manhole. The motor is activated or switched ON with the help of the toggle switch provided. Initially, when the bucket begins to enter the manhole, it remains closed. As the bucket reaches halfway the buckets are opened with the help of the actuator which is activated with the help of the toggle switch provided.

Once the bucket reaches a certain depth the motor can be switched OFF manually or it automatically switches OFF once it touches the limit switch that is provided at the top of the frame and the circuit is open. Once the required depth is reached, the waste that is accumulated in the manhole is collected in the bucket by closing it again with the help of the toggle switch that is provided. Once the bucket has successfully collected the waste, the motor is again activated in the reverse direction in order to lift the waste that has been collected.

Once the bucket comes out of the manhole, the motor again can be switched OFF manually or it will automatically switch OFF once it comes in contact with the limit switch fixed at the bottom of the frame. After the motor switches OFF, the frame carrying the pipe and the bucket can be swivelled around to the collecting tank that is provided at the rear. The waste that is

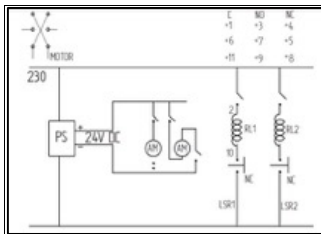
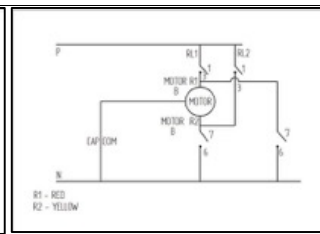

Fig 15, 16: Relay wiring



2.3.4 OUTCOME OF FINAL MODEL



Fig 17: Outcome of final model (View 1)



Fig 18: Outcome of final model (View 2)



collected in the bucket is dumped into the tank and the frame is swivelled back and the process continues.

Once the cleaning procedure is complete, the frame which is hinged at the bottom can be lifted and made to rest in an inclined position making it easy to be transported. While the manual machine has to be inserted into the manhole and the buckets can be opened by pressing the lever that is provided at the top and thus the waste accumulated in the manhole can be collected. Once the waste is collected, the other lever provided has to be pressed in order to close the buckets and the entire setup has to be lifted up and the waste collected can be dumped in a bin.

2.5 TECHNICAL SPECIFICATIONS AND CALCULATIONS

<p>TROLLEY FRAME: Material Used : Mild Steel Length : 1500mm Width : 900mm Height : 300mm</p>	<p>BUCKET : Length : 290mm Height : 212mm Width : 288mm</p>	<p>PIPE : 1. Square: Length :3000mm Dimension : 60X60mm 2. Circular: Length : 140mm Diameter : 50mm</p>
<p>FRAME : Dimension : 60X60mm Length : 600mm Width : 600mm</p>	<p>AC MOTOR : Single Phase RPM : 1400 HP : 1/6th Frequency : 50hz Shaft diameter : 11mm Current : 0.85A</p>	<p>GEAR BOX : Shaft Material : Mild steel Output Shaft diameter : Ratio : 1: 100 Length : 122mm Width : 122mm</p>
<p>LINEAR ACTUATOR : Stroke : 100mm Voltage : 24V DC Current : 2A</p>	<p>SWITCHED MODE POWER SUPPLY (SMPS) : Input Voltage : 230V AC Output Voltage : 24V DC Current : 2A</p>	<p>SPROCKETS : Material used : Hardened Steel Diameter : 78mm – 1 no.'s, 101mm – 2no.'s No. of teeth : 18 & 24</p>
<p>CHAIN : Length : 3000mm Pitch : 12mm No. of links : 288</p>	<p>LIMIT SWITCH : Current : 10A Voltage : 500V AC (1NO + 1NC)</p>	<p>RELAYS : Current : 5A Voltage : 240V</p>

CALCULATIONS:

By considering all parameters, the required torque was found to be **T = 1.5kg-m**.

Torque developed :
P = 120W / 1/6th HP
N = 16RPM
P = 2*π*N*T/4500..... (HP)

T = P*4500/2*π*N..... (Kg-m)

T = 7.1 kg-m

The efficiency is 50% due to the use of worm and worm gear.

∴ T = 7.12 = **3.55 kg-m**

Due to the usage of a single-phase motor the efficiency loss is 25%

∴ T = 3.55-(3.55* 0.25) = **2.6125kg-m**

III. COST ESTIMATION

SL NO.	PARTICULARS	QUANTITY	COST (in INR)	TOTAL (in INR)
1.	AC motor	1	4500	4500
2.	Gear Box	1	5500	5500
3.	Sprockets	3	80	240
4.	Chain	2	120	240
5.	Actuator	1	300	300
6.	SMPS	1	600	600
7.	Switches	2	50	100
8.	Relays	2	400	800
9.	Limit Switches	2	300	600
10.	MS pipes, Sheets and angle	-	-	5500
11.	Rubber Tyres	4	500	2000
12.	Miscellaneous		-	2500
TOTAL				22880/-

IV. RESULTS AND DISCUSSIONS

4.1 RESULTS FROM TRIAL RUNS

The manhole cleaning machines intend to reduce the health hazards that are caused when a worker enters the manhole and to keep the environment clean.

The following tests were conducted, and the results are as follows:

- Depth of the manhole: The depth of the manholes varies from 1 meter to about 3 meters. Our machine is designed to reach a depth of about 1.8 meters as most of the manholes have that depth.
- Weight Lifted: Our machine is designed to lift about 2.5 kgs of waste with the constraint of the parameters and the budget.



4.2 ADVANTAGES AND DISADVANTAGES

ADVANTAGES:

- The machines are comparatively compact and can be transported easily.
- The machines are cost-effective.
- The machines do not cause unemployment.
- The machines use simple mechanisms.
- The machines are rigid and stable.
- The machines require less maintenance.
- The machines are comparatively lighter.
- No special skill is required to operate the machines.
- The machines require less time than the conventional methods.
- The machines can be operated for long periods.

DISADVANTAGES:

- Rusting of few parts can occur hence regular replacement is required.
- Regular cleaning of the buckets is required.
- It can be operated at a maximum depth of 1.8 meters.

4.3 APPLICATIONS

- Accumulated wastes in the manhole can be collected easily.
- It can also be used for cleaning other hazardous wastes.
- Solid and semi-solid wastes can be collected.
- Mechanisms can be easily analyzed and studied by a layman.

V. CONCLUSIONS

Cleaning of drains has always been a problem. The impurities present in water can cause blockage inflow also can prove to be hazardous and cause diseases. These impurities present in the manholes can cause blockage of the drainage system. To avoid such situations these impurities should be cleaned from time to time for the smooth working of the drainage system. Our project aims at cleaning the manholes from time to time so as to remove the waste, avoid blockages and overflow.

Now we can conclude that with the help of our project, THE COMPACT MULTI – OPERATIONAL MANHOLE CLEANING MACHINE:

This project can be implemented in both urban and rural areas, and cleaning of the manholes can be done effectively. We have fabricated this machine keeping in mind the SWACHH BHARATH ABHIYAAN. Our project is very useful in monsoon because in rainy seasons, our drains are usually overflowing and are blocked by solid wastes.

• FUTURE SCOPE IN THE INDUSTRIAL SECTOR:

As a young and fast-growing nation, we are concentrating to pull out the maximum from our manufacturing sector with a touch of start-ups as a thing of sub-topic focus. Our Project, as being new in the market, will provide the entrepreneurs the much-needed ideas to blend the technology with social benefits and to maintain the cleanliness of the environment.

• FUTURE SCOPE FOR SOCIETY:

This project aims at helping the workers who manually enter the manholes and clean them due to which some of them even lose their lives due to the harmful environment inside. We have made our project affordable to society so that implemented both in rural and urban areas. The project is also compact which is an added advantage as it does not trouble the commuters. Our machines house very simple mechanisms which make it easy for others to analyze, study and also make the necessary modifications.

• FUTURE SCOPE FOR ACADEMICS:

Drainage Cleaning System is basically an agglomeration of the basic mechanical components that we have gone through regressively during our past four years of the curriculum. The components that majorly consist of the Chain drives, Bearings, etc. are integrated to build a structurally simple project.

• FUTURE SCOPE OF THE PROJECT:

The project manhole cleaning machine has a future in the mechanical domain. With the addition of advanced technology and better usage of the material for its fabrication, the project has a better scope in the near future to come.

VI. CONFLICT OF INTEREST

The authors declare that there is no conflict of interest related to the publication of this article.

VII. ACKNOWLEDGEMENT

We are profoundly honored to acknowledge the Management of AMC Engineering College, Bangalore for providing us an opportunity to study and support towards the completion of our project work.

We take it as a privilege in expressing our sincere gratitude, heartfelt respect and regards to our guide **Prof. Manjunatha C**, Department of Mechanical Engineering, AMCEC, Bangalore, for the co-operation extended to us in completion of our project work. It gives us immense pleasure to express our deep sense of gratitude to **Dr. A G Nataraj**, our beloved Principal, AMCEC, whose words of advice have always been a constant source of inspiration for us. It gives us pleasure to thank **Dr. A K Murthy**, Dean Academics, AMCEC for his motivation and encouragement in completing this project. We would like to



express our heartfelt thanks to **Dr. Girsha C**, Head of the Department of Mechanical Engineering, for his valuable advice and encouragement in completing this project work. Thanks also to our Class Faculty, **Prof. Geetha T M** for all the help extended to us in completing project phase-I.

VIII. REFERENCES

- [1] Divya Gandhu. **THE HINDU**, The first robots clean India's sewers, September 01, 2018
- [2] **Genrobotic Innovations Pvt Ltd**, Thiruvananthapuram, Kerala, India.
- [3] **2nd International Conference on Current Research Trends in Engineering and Technology**© 2018 IJSRSET | Volume 4 | Issue 5 | Print ISSN: 2395-1990 | Online ISSN: 2394-4099 Themed Section: Engineering and Technology.
- [4] **International Journal of Engineering, Science and Mathematics** Vol. 7 Issue4, April 2018 (special issue NCIME) ISSN: 2320-0294 Impact Factor: 6.765

IJEAST

INTERNATIONAL JOURNAL
OF ENGINEERING APPLIED SCIENCE
AND TECHNOLOGY

ABOUT IJEAST

International Journal of Engineering Applied Science and Technology (IJEAST) is a peer-reviewed, open access journal that publishes high-quality research papers in the field of Engineering, Applied Science and Technology.

IJEAST aims to provide a platform for researchers, academicians, and professionals to share their innovative ideas, research findings, and practical experiences with the global scientific community.

FOCUS AREAS

- Engineering
- Applied Science
- Technology
- Innovation & Development
- Interdisciplinary Studies



PEER REVIEWED

All submissions are rigorously peer reviewed to ensure quality.



OPEN ACCESS

Free and unrestricted access to research for all.



GLOBAL REACH

Connecting researchers and professionals worldwide.



TIMELY PUBLICATION

We ensure a swift and efficient publication process.



For more information, visit our website

www.ijeast.com



INTERNATIONAL JOURNAL
OF ENGINEERING APPLIED SCIENCE
AND TECHNOLOGY

✉ editor@ijeast.com

🌐 www.ijeast.com

📍 India



2455-2143