



IJEAST

INTERNATIONAL JOURNAL
OF ENGINEERING APPLIED SCIENCE
AND TECHNOLOGY



VOLUME : 2 ISSUE : 3 Print / Issue Publication Date: 09-Mar-2017



ISSN : 2455-2143



Indexed In



WWW.IJEAST.COM

editor@ijeast.com



AQUA COMMUNICATION USING MODEM

RAMYA.B
 Department of ECE
 HYDERABAD, TELANGANA, INDIA

Abstract— While wireless communication technology today has become part of our daily life, the idea of wireless under sea communications may still seem far-fetched. However, research has been active for over a decade on designing the methods for wireless information transmission underwater. Significant progress has been made in terrestrial sensor net-works to revolutionize sensing and data collection. To bring the concept of long-lived, dense sensor networks to the underwater environment, there is a compelling need to develop low-cost and low-power acoustic modems for short-range communications. This paper explains about Aqua communication using modem and presents designing and developing such a modem. The word "modem" is a contraction of the words modulator-demodulator. A modem is typically used to send digital data over a phoneline. The sending modem modulates the data into a signal that is compatible with the phone line, and the receiving modem demodulates the signal back into digital data. Wireless modems convert digital data into radio signals and back We therefore explore a complementary path that emphasizes simple but numerous devices that benefit from dense sensing (e.g., eight or more neighbours per node, rather than one or two) and shorter-range communication. In addition to simpler node-to-node channels due to shorter range, higher-level approaches can compensate for channel problems through approaches such as routing, link-layer re-transmission and application-layer coding.

I. INTRODUCTION

Sensor networks are beginning to revolutionize data collection in the physical world, relatively little work has been done to explore how sensor networks apply underwater. wireless communication, is nothing but dense deployments (each sensor may have eight or more neighbours), self-configuration and local processing, and maximizing the utility of any energy consumed.

Aqua communication is an underwater wireless communication system in which the acoustic signals (waves) carry the digital information through an underwater channel. Electromagnetic waves are not used as they propagate over short distances. Over the past decades, heavy cables were used to establish high speed connection in between the remote end

and the surface. To overcome such difficulties, underwater wireless communication system has come into existence.

II. BLOCK DIAGRAM

A. Watermark embedding algorithm –

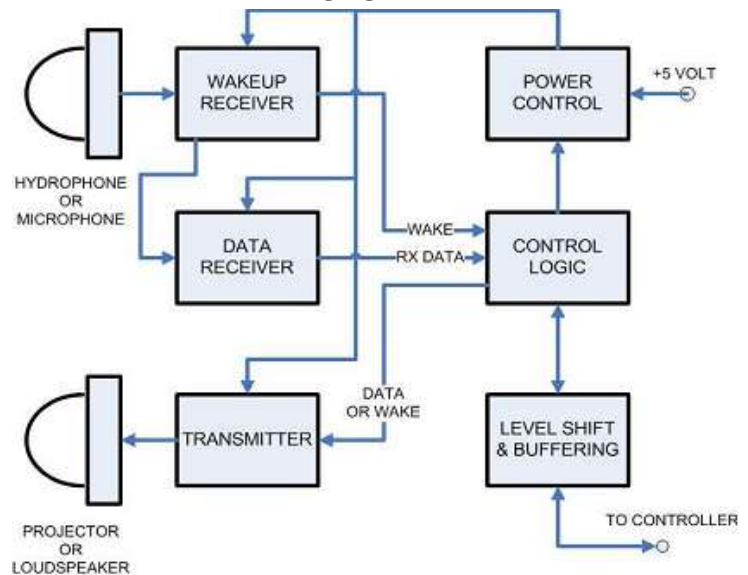

ACOUSTIC MODEMS:

- It employs advanced modulation scheme and channel equalization for improved signal to noise ratio
- Employs high performance error detection and correction coding scheme which reduces the bit error to less than 10^{-7} .

PARTS OF AN ACOUSTIC MODEM:

1. DSP board
2. AFE(analog front end)board
3. DC/DC converter

Acoustic modems offer the possibility of wireless communication under water. For those who have dealt with cables in unfavorable ocean environments, this is an elegant solution for communication. Typical applications for acoustic

modems are real time systems or previously deployed systems where data needs to be periodically downloaded. Despite the allure of wireless communication, acoustic modems are not without their limitations and challenges. To help you decide whether an acoustic modem is suitable for your particular communication needs.

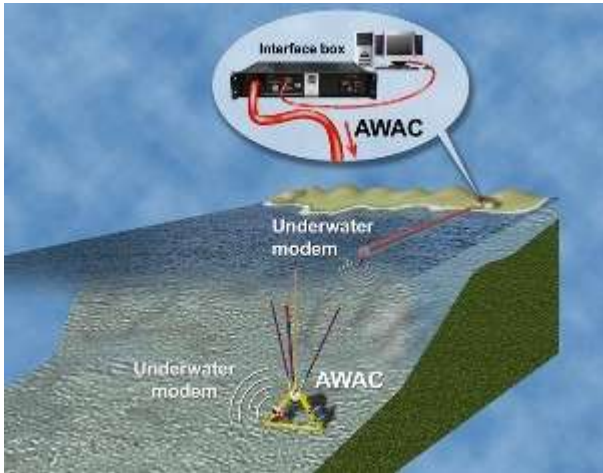

Functional Description Underwater acoustic communication is relatively slow when compared to radio communication. This has to do largely with the speed of sound in water which is roughly 1500 meters/second. The result is a relatively low baud rate (typically 9600 baud).

Not only is the medium slow but there are complications with the transmission due to signal absorption, geometric spreading losses, boundary effects, and multipath to name a few. Manufacturers have several techniques they employ to handle these challenges. The techniques come in the form of signal processing, data packaging, and coding schemes. These techniques, which are not the same for all manufacturers, help ensure reliable communication and possibly identify bit loss and/or repair these lost portions of data at the receiver end.

There are several methods of transmitting data acoustically (i.e. modulation), but the most common method is the use of spread spectrum. Briefly, this is a method of sending data at several different frequencies (Multi-Frequency Shifted Key, MFSK) in order to increase data throughput. Another modulation scheme is the Phase Shifted Key, or PSK; this modulation scheme permits higher baud rates but is more susceptible to error sources.

The data are packed to ensure that a few errors will not corrupt the entire data message. This means that large amounts of data are sent as a series of these data packages. A typical data package is approximately 4 kb. A package contains the data plus additional bytes of data for identifying the package

boundaries, modem identity, checksum, and error correction codes.

Some modems allow for a configuration where a retransmission request is sent from the receiver if errors are detected in a data package. The implication of lost data is that it must be retransmitted. This affects the effective baud rate if a modem is operating at a high acoustic baud rate.

III. WORKING

Among the first underwater acoustic systems was the submarine communication system developed in the USA around the end of the Second World War. It used analogue modulation in the 8–11 kHz band (single-sideband amplitude modulation). Research has since advanced, pushing digital modulation–detection techniques into the forefront of modern acoustic communications. At present, several types of acoustic modems are available commercially, typically offering up to a few kilobits per second (kbps) over distances up to a few kilometres. Considerably higher bit rates have been demonstrated, but these results are still in the domain of experimental research.

Underwater wireless sensing systems are envisioned for stand-alone applications and control of autonomous underwater vehicles (AUVs), and as an addition to cabled systems. For example, cabled ocean observatories are being built on submarine cables to deploy an extensive fibre-optic network of sensors (cameras, wave sensors and seismometers) covering miles of ocean floor. These cables can support communication access points, very much as cellular base stations are connected to the telephone network, allowing users to move and communicate from places where cables cannot reach. Another example is cabled submersibles, also known as remotely operated vehicles (ROVs). These vehicles, which may weigh more than 10 metric tonnes, are connected to the mother ship by a cable that can extend over several kilometres and deliver high power to the remote end, along with high-speed communication signals. A popular example of an ROV/AUV tandem is the Alvin/Jason pair of vehicles deployed by the Woods Hole Oceanographic Institution (WHOI) in 1985 to discover Titanic. Such vehicles were also instrumental in the discovery of hydro-thermal vents, sources of extremely hot water on the bottom of deep ocean, which revealed forms of life different from any others previously known. The first vents were found in the late 1970s, and new ones are still being discovered. The importance of such discoveries is comparable only to space missions, and so is the technology that supports them.

The modem hardware is split into three main portions: a wakeup receiver, a data receiver, and a single transmitter. The transmitter has three output frequencies, which correspond to the data mark, data space, and wakeup tone. It is not possible to transmit data and the wakeup tone simultaneously. The

entire circuit operates from a 5 volt power supply. Level shifters are used to provide compatibility with CMOS logic levels between 2.8 and 5.0 Volts. Our current prototype contains all the hardware on a single printed circuit board measured as 4 by 5 inches. Figure 2 is a picture of the board with the wakeup receiver and data receiver installed. We next describe the details of each major part of the modem.

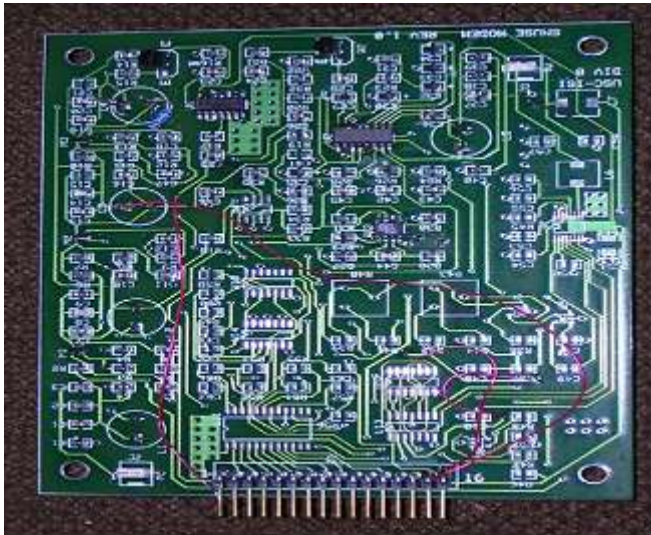

Fig.2:board with the wakeup receiver and data receiver installed



3.1 Wakeup Receiver

The principal goals for the wakeup receiver are good sensitivity and very low power consumption. The only purpose of the receiver is to monitor the total energy level present in a narrow band of frequencies, and to produce an interrupt.

We have chosen 18 kHz as the frequency for the wakeup tone. This is an attractive frequency based on the background noise levels, as well as the attenuation characteristics in the ocean; both factors are frequency dependent. This frequency also lies in the normal audio band (20-20kHz) and allows use of standard audio hardware and software. Our chosen bandwidth for the wakeup receiver is about 300 Hz. There are several

possible ways to produce such a filter L/C with passive inductors and capacitors Active RC using operational amplifiers Digital an ADC followed by a DSP. The need for very low power argues against the active RC and digital designs.

3.2 Data Receiver

The data receiver is a conventional design based on a commercial FM intermediate frequency demodulator chip, the Philips SA604A. Whenever the data receiver is turned on, the first stage of the wakeup receiver is also powered. Due to the channel characteristics in the underwater environment we are sending wideband FM. This requires several changes in the way we apply the SA604A. First we use a simple, single pole low pass and single pole high pass filter to couple between the stages of the SA604A. A narrow band design typically uses an LC resonator or ceramic band pass filter.

3.3 Transmitter

The transmitter uses a Linear Technology LTC6900 low power oscillator as a voltage controlled oscillator (VCO). The circuit design is based on Linear Technology Design. The oscillator output feeds into a Texas Instruments TPA2000D1 Class D Audio Power Amplifier. This is capable of delivering 2 watts into a 4 Ohm load. By selecting lower gains we reduce the output power level, but extend battery life. We hope that the combination of RSSI and variable output power will encourage development of energy efficient communication protocols. The transmitter efficiency ranges from 80 to 90 percent.

3.4 Transducers

In the ultimate application of underwater communications, we will use piezoelectric transducers. These are high impedance devices, and the modem circuitry is designed for high impedance operation. At the present time we are using Audax brand hi-fi tweeters, both as transmitter and as microphones. Switching over to hydrophones will only require changing the input and output impedance matching networks

3.5 Power Control

The modem operates from a single 5 volt supply. The choice of supply voltage is driven by the dual gate FETs used in the wakeup receiver. These are operated from a 12 volt supply in their intended application. While the modem is basically a 5 volt design we need to interface with microcontrollers such as the Mica2 mote. The modem design includes two features to allow interfacing to any voltage level from 2.8 to 5 volts. Digital input and outputs are tied through a Texas Instruments SN74TVC3010 voltage clamp which limits all digital output signals to the microcontroller supply voltage.

In shallow water, multi-path occurs due to signal reflection from the surface and bottom, as illustrated in Figure . In deep water, it occurs due to ray bending, i.e. the tendency of acoustic waves to travel along the axis of lowest sound speed. Figure 2 shows an ensemble of channel responses obtained in deep water. With limited bandwidth, the signal is subject to multi-path propagation, which is particularly pronounced on

horizontal channels. In shallow water, multipath occurs due to signal reflection from the surface and bottom, as illustrated in Figure 4. In deep water, it occurs due to ray bending, i.e. the tendency of acoustic waves to travel along the axis of lowest sound speed. Figure 4 shows an ensemble of channel responses obtained in deep water. The multi-path spread, measured along the delay axis, is on the order of 10 ms in this example. The channel response varies in time, and also changes if the receiver moves. Regardless of its origin, multipath propagation creates signal echoes, resulting in inter symbol interference in a digital communication system.

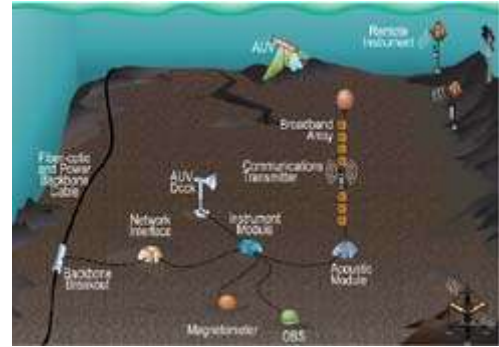

The concept of a deep-sea observatory in aqua communication using modem

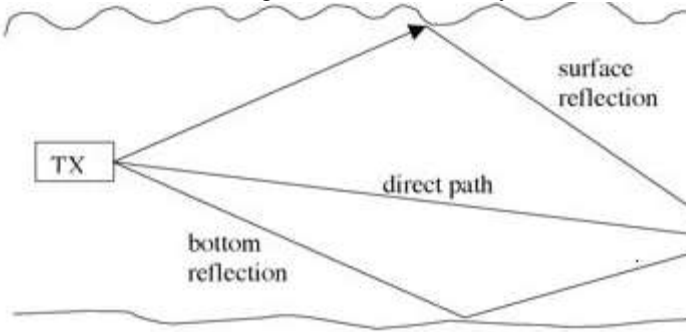

ADVANTAGES:

- It avoids data spoofing.
- It avoids privacy leakage.
- Pollution monitoring

DISADVANTAGES:

- Battery power is limited and battery cannot recharge easily
- The available bandwidth is severely limited.
- Underwater sensors are prone to failure due to fouling, corrosion, etc.
- Highly affected by environmental and natural factors such as heterogenities of water column, variations of sound velocity and depth, temperature and salinity, etc.
- Future ocean environment would be increasingly complicated.
- Optical waves are not attenuated but are affected by scattering.

Fig.4:Shallow water multipath propagation: in addition to the direct path, the signal propagates via reflections from the surface and bottom

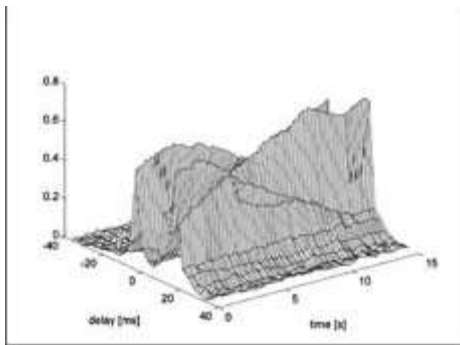

In addition to serving as stand-alone systems, underwater acoustic networks will find application in more complex, heterogeneous systems for ocean observation. Figure 5 shows the concept of a deep-sea observatory. At the core of this system is an underwater cable that hosts a multitude of sensors and instruments, and provides high-speed connection to the surface.

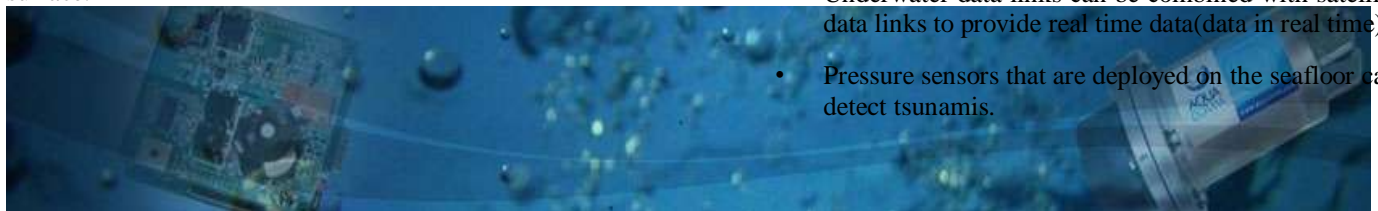

APPLICATIONS:

- Can be used to provide early warnings of tsunamis due to the undersea earth quakes
- Underwater data links can be combined with satellite data links to provide real time data(data in real time)
- Pressure sensors that are deployed on the seafloor can detect tsunamis.



Features	Attributes	Benefits
High reliability of communications	<ul style="list-style-type: none"> • Purpose-designed algorithms and electronics for highly reliable underwater communications • Shown to be the most reliable in numerous independent tests by major organisations • Proven over many years of commercial use 	<ul style="list-style-type: none"> • Works in virtually any real-world sea state where others have failed • Dramatically reduce operational risks and maintenance costs • Brings certainty and confidence that your application will work
Low power consumption	<ul style="list-style-type: none"> • Uses 10-20 times less power than competing products 	<ul style="list-style-type: none"> • Lower maintenance requirements and total cost of ownership • Broadens the types of applications AquaComm can be used for
Ease of integration	<ul style="list-style-type: none"> • DSPComm is an OEM specialist • Small form factor, lightweight • Transparent command modes • Easy to understand command structure • Standard RS-232 connection for DC-DTE • Quickly and successfully integrated with numerous products 	<ul style="list-style-type: none"> • Quick and low-cost integration • Lower total cost of ownership
Small form factor and lightweight	<ul style="list-style-type: none"> • Less than half the size of competing modems 	<ul style="list-style-type: none"> • Broadens the types of applications AquaComm can be used for



IV. CONCLUSION

Wireless information transmission through the ocean is one of the enabling technologies for the development of future ocean-observation systems and sensor networks. Applications of underwater sensing range from oil industry to aquaculture, and include instrument monitoring, pollution control, climate recording, prediction of natural disturbances, search and survey missions, and study of marine life.

Among the first underwater acoustic systems was the submarine communication system developed in the USA around the end of the Second World War. It used analogue modulation in the 8–11 kHz band (single-sideband amplitude modulation). Research has since advanced, pushing digital modulation–detection techniques into the forefront of modern acoustic communications. At present, several types of acoustic modems are available commercially, typically offering up to a few kilobits per second (kbps) over distances up to a few kilometres. Considerably higher bit rates have been demonstrated, but these results are still in the domain of experimental research

V. REFERENCE

- [1] I. F. Akyildiz, D. Pompili, and T. Melodia, "Underwater Acoustic Sensor Networks: Research Challenges," *Ad Hoc Networks* (Elsevier), vol. 3, no. 3, pp. 257-279, March 2005.
- [2] E. Demirors, G. Sklivanitis, T. Melodia, S. N. Batalama, and D. A. Pados, "Software-defined Underwater Acoustic Networks: Toward a High-rate Real-time Reconfigurable Modem," *IEEE Communications Magazine*, vol. 53, no. 11, pp. 64 - 71, November 2015.
- [3] Proc. AIP Conf. Acoustic Particle Velocity Sensors: Design, Performance, and Applications, Mystic, CT, 1995.
- [4] AquaSeNT, "OFDM Acoustic Modem," <http://www.aquasent.com/>.

IJEAST

INTERNATIONAL JOURNAL
OF ENGINEERING APPLIED SCIENCE
AND TECHNOLOGY

ABOUT IJEAST

International Journal of Engineering Applied Science and Technology (IJEAST) is a peer-reviewed, open access journal that publishes high-quality research papers in the field of Engineering, Applied Science and Technology.

IJEAST aims to provide a platform for researchers, academicians, and professionals to share their innovative ideas, research findings, and practical experiences with the global scientific community.

FOCUS AREAS

- Engineering
- Applied Science
- Technology
- Innovation & Development
- Interdisciplinary Studies



PEER REVIEWED

All submissions are rigorously peer reviewed to ensure quality.



OPEN ACCESS

Free and unrestricted access to research for all.



GLOBAL REACH

Connecting researchers and professionals worldwide.



TIMELY PUBLICATION

We ensure a swift and efficient publication process.



For more information, visit our website
www.ijeast.com



INTERNATIONAL JOURNAL
OF ENGINEERING APPLIED SCIENCE
AND TECHNOLOGY

✉ editor@ijeast.com

🌐 www.ijeast.com

📍 India



2455-2143