



# IJEAST

INTERNATIONAL JOURNAL  
OF ENGINEERING APPLIED SCIENCE  
AND TECHNOLOGY



**VOLUME : 9    ISSUE : 03    Print / Issue Publication Date: 09-Oct-2024**



**ISSN : 2455-2143**



**DOI : 10.33564/IJEAST.2024.v09i03.006**

Indexed In



[WWW.IJEAST.COM](http://WWW.IJEAST.COM)

[editor@ijeast.com](mailto:editor@ijeast.com)



# GRANTEES INFORMATION SYSTEM (GIS)

Jaycee M. Gamayon, Neil Brylle B. Serentas, Mellanie S. Gambe, Ryan E. Balisi  
College of Computer Studies,  
St. Peter's College, Iligan City, Philippines

**Abstract:** The aim of the study is to provide grantees with, scholarship in-charges, and bookkeepers tools to help them manage their daily tasks while interacting with a grantees information system. The study also intends to assess the system's adoption and efficacy using the TAM theory. A 5-point Likert Scale questionnaire is used by the researchers. In addition, there are thirty-seven (37) respondents from various year levels and courses at St. Peters College. Respondents were encouraged to use the grantees' information system. As a result of the evaluation, the majority of respondents accepted the Grantees Information System. The results show that the system has a favorable impact and benefits grantees, scholarship in-charges, and bookkeepers.

**Keywords:** Information system, Tasks management, TAM theory

## I. INTRODUCTION

In higher education, the higher education authority provides its students with various scholarships like The Tertiary Education Subsidy (TES), the Tulong Dunong Program (TDP), and other Student Financial Assistance Programs (STUFAPs). These scholarships are substantial in favor of many students for pursuing higher education dreams. However, managing scholarships could be quite complicated, especially on the part of scholarship coordinators who abide by CHED's rules. This study investigates problems facing Scholarship coordinators and how students can apply for such scholarships. The Grantees Information System, also known as GIS, is a web-based system designed to make management of scholarships easier. It's a system that connects students and coordinators for easy handling of scholarships, thus helping students to access educational opportunities.

St. Peter's College uses a manual system in managing and maintaining the grantees of the said scholarship. A problem was encountered by the scholarship in Charge in managing the grantee's data, especially when releasing the funds to the grant students. Due to the manual system in managing grantees' data, the status of the scholarship for grantees cannot easily be viewed, and upon releasing the funds, the grantees have to know the date to actually release them. Since an information system is needed, the grantees would usually have to go to the grantee's Facebook page or actually go to school just to see the date of the release of the funds. The school needs to generate reports for CHED. The

problem within the school is that, although they submit reports to CHED regarding grantees' billing, they are made to wait to do so. In general, non-availability of GIS in the school leads to lack of transparency, difficulty tracking the financial aid, and compliance concerns. For instance, Forrester (2019) realized that with critical data becoming increasingly complex, school administrators and educators are pressured into processing and structuring the large volume of data involved in the SMIS within a limited time framework.

The researchers will design a GIS, as stated in the problem above, which would help in the efficient management, manipulation, and organization of data concerning the grantees.

The research article written by Ranjith in the year 2023 shall deal with automation of the students' information system to allow access beyond the organizational boundary. This helps in reducing processing time and increasing accessibility. It consists of an easy user interface and effective data management. The major modules include tracking the attendance of students, analyzing the results, monitoring information about placement, and maintaining attendance of faculties. The proposed research on the GIS is unique and functional in ways that the preceding studies on the automation of student information systems do not possess.

This study is targeted to solve the current problems facing this school in regard to the management of data about the grantees. The proposed system will afford an avenue where school administrators can have easy access to grantees' information at any time of the day and anywhere. This would make less cumbersome or fasten the administration process of such data, which may not be the major points addressed by related studies focusing on managing student data within the organization and lacking some features that the proposed research offers. Generally, this current study on Grantee's Information System has provided a new approach in keeping grantees' data more efficiently and effectively, and in a more user-friendly way than existing studies on the student information system.

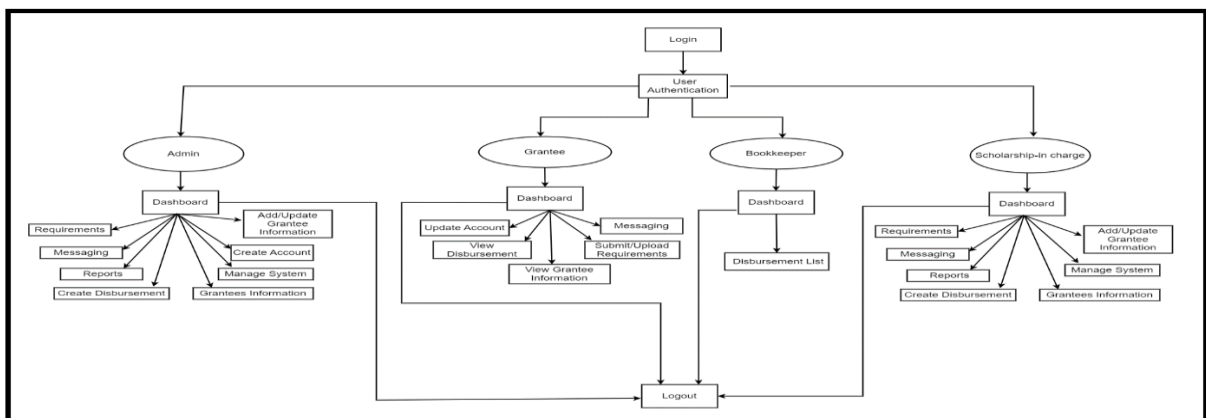
The researchers employed Laravel, XAMPP, and AdminLTE in the development process. Laravel is an open-source PHP framework recognized for its elegant syntax and extensive features. XAMPP is a free, open-source web server package that encompasses Apache HTTP Server, MySQL database, PHP, Perl, and other essential web development tools. AdminLTE, a widely-used open-source

dashboard and control panel theme, is built on the Bootstrap framework and is popular for web applications. In the study, there are advantages for grantees, the scholarship coordinator, and the school. For one, the system will provide more accurate and up-to-date details about grantees. All parties involved in the scholarship will benefit from this information. On one hand, benefactors are able to come up with better decisions on whether to continually support the scholarship program or not. For another, the system can facilitate benefactors' needs to account for their donations and see to it that they serve purposes that are worthwhile. This would provide reason to increase trust and confidence in the scholarship program, making more benefactors participate in financial support.

The figures 1 and 2 together provide a comprehensive view of the research framework and operational process. Figure 1 introduces the Input-Process-Output model, beginning with input derived from existing scholarship and grantees' feedback. This model employs the Prototype Model for design and prototyping, resulting in the development of the Grantee's Information System (GIS) as the tangible output. Figure 2 complements this by detailing the system's functionality, starting with user login and authentication to determine roles such as scholarship in Charge, administrator, grantee, or bookkeeper. Once authenticated, users proceed to their respective dashboards, ensuring effective navigation and utilization of the GIS capabilities across the entire system flow.



**Figure 1.** Conceptual Framework Using IPO Model



**Figure 2.** Grantees' Information System Framework

## II. LITERATURE REVIEW

The research and literature reviewed in this chapter offer foundational background and theoretical insights pertinent to the proposed study.

### 2.1 Information System

An information system is an organized, formal, sociotechnical framework intended to gather, handle, organize, and disperse knowledge. Information systems consist of the following four elements from a sociotechnical standpoint: task, people, framework and technology.



According to Hendriyati et al. (2022), one of the most crucial elements in higher education is the development of an integrated information system and effective data management. This is significant because, in all postsecondary institutions, there is a high need for traits that are both complete and relevant to the academic discipline. Systems with varying degrees of capability operate on their own, which presents numerous challenges for the school's IT infrastructure. Technology is beneficial to a college's management system since it helps manage data, produces useful information for the community, and benefits institutions.

Forrester (2019) highlighted that while school management information systems (SMIS) offer significant benefits, many educational institutions struggle to establish a data-driven culture due to challenges with data quality in the era of big data. The true potential of SMIS remains underutilized as schools face issues related to data integrity. Additionally, advancements in information technology, evolving information exchange practices, increasing societal demands, and contemporary management perspectives have profoundly impacted organizational practices and operations.

According to Lestariningsih et al. (2019), the success rate of information system implementations applied to public and private universities is required to assess the maturity level of college information system management. This enables college management to identify areas of deficiency and determine the best course for developing and managing the information system. Because information technology includes all activities from buying and processing to broadcasting information, its implementation has expanded to all domains today, including public and private colleges. In order to accomplish the goals of good governance through the implementation of the information system, a framework from planning to evaluation is required.

According to Yang and Wang (2022), as science and technology have advanced, blockchain has become a popular data security tool that is being utilized in many spheres of society because to its immutability, uniqueness, smart contract functionality, and decentralized structure. Education, services, and industry are a few examples. Blockchain technology has found more applications as China's educational system develops. Three sectors comprise the majority of blockchain applications in China's education sector: building education fundamental platforms, managing instructional information, and managing educational resources.

According to Sa'diah et al. (2021), information is also crucial for all individuals and groups inside the company since it is designed to make use easier and more advantageous for users. An Information System (SI) will use information in a more methodical way for particular objectives. Information is strategic, necessary data that gives each person useful information.

## **2.2 Scholarship System**

Alvaro and Gabayan Jr. (2021) discussed how quickly technology develops and expands. Technology offers various information services in agriculture, economics, and education. As a result, today's youth use technology in education across the globe for school reporting, enrollment, and scholarships. A software program called "Scholarship Information System" was created to manage the branch, college, and scholarship information for students. The software is handy for locating qualified individuals across many colleges. The project identifies eligible applicants from the student roster by considering factors such as academic performance, caste, sports achievements, and financial status.

According to Al Qushary and Salam (2020), an accomplishment scholarship is one of the SDN | GIpMinyeukSigli initiatives offered by a school to assist students who perform well academically but have fewer financial means. Many students who have academic achievement but cannot afford the expense can continue their education without confusion or worry about money thanks to our achievement scholarship program. Because this accomplishment scholarship program is specifically intended for the children of SDN I GIpMinyeukSigli, it will handle a significant amount of children's data. Achievement scholarship awardees need an information system in order to manage enormous children's data efficiently.

According to Prijayanti et al. (2019), one of the measures universities take to determine if a student contributes to the university is scholarship monitoring. One of the organizations that perform this kind of monitoring is Universitas Muhammadiyah Magelang. Monitoring also attempts to improve human resource capacity through education. The Student and Alumni Development Institute (LPMA) now collects physical copies of files after each semester, which results in data loss and duplication. The scholarship working group then summarizes the monitoring findings to establish the volume of student activities to be utilized as a benchmark for the following scholarship.

According to Komsari and Airlangga (2019), a scholarship is a package of financial aid awarded to students who fulfill the eligibility requirements. There are numerous scholarships offered by UNWAHA as well as outside of it. But this information needs to be shared with a lot more individuals. Scholarship applicants may or may not be connected on social media, but the current scholarship information marketing strategy still depends on it. This scholarship is designed and disseminated using the waterfall process, a methodical system development strategy. This method of sharing scholarship information was created to manage scholarships and facilitate students' instant access to information. Students may find it easier to apply for scholarships and share scholarship information with others if this other method of distribution is used.

Ibrahim (2021) emphasized the importance of an



information system for providing students with comprehensive details about scholarships offered by Bidikmisi, aiming to streamline the monitoring process. The objective of this information is to simplify access so that recipients of the Bidikmisi scholarship can better understand the program. The development of an information system for managing scholarship monitoring data at Ar-Raniry State Islamic University involves several steps: input design, output design, process design, control design, labor design, and cost design. This approach is based on a proposed website envisioned by the author, with model prototyping used for concurrent application design.

### **2.3 Student Profiling**

Data mining, according to Alan and Temiz (2019), is essential to decision-making in educational institutions. It takes a lot of labor to manually analyze vast amounts of data in order to identify the pattern. Rather than employing such a rigorous approach, data mining techniques can be used to characterize the students. An academic group of high school graduates was the subject of this investigation. To help teachers, parents, and school administration better understand their children and support their achievement, the developed guidelines are extremely important. Social media and institutional databases hold a significant amount of data. Assessing the data is just as vital as obtaining and safeguarding it. School databases are one type of media where data is stored. Management of schools and teachers can benefit greatly from the analysis of the data in these databases and the information that can be obtained from it. Englander et al. (2021) highlight that research often identifies student engagement as the most significant predictor of learning and growth (Burch et al., 2015; Schaufeli et al., 2002). This aspect is recognized as a key objective for higher education institutions (Haug et al., 2018). While higher education institutions are responsible for creating environments that support and foster student learning, it is ultimately the students who are responsible for their own educational outcomes, as noted by Zhoc et al. (2019).

Gasiewski et al. (2011) assert that defining and maintaining involvement depends just as much on the attitudes and behaviors of instructors as it does on student conduct. Five key categories of student engagement—motivation, learning environment, institutional attachment, satisfaction, and external commitment—have been defined in this study, which has broadened the analysis. In light of university policy and the practical differences in participation between identified student groups, the research's conclusion centers on the potential advantages of student motivation profiling (Krause & Coates, 2008). Higher education institutions' efficacy evaluations should place a premium on knowing why students engage and what tactics they employ.

Man and Azhan (2019) explain that the concept of web user profiling, which involves creating semantically-based user

profiles that include contact details, educational background, demographics, and preferences or interests from unstructured web data, serves as the foundation for student profiling in e-learning. This approach addresses key issues in understanding user behavior on online platforms. The process involves collecting, processing, and analyzing data related to student behavior or actions. The Experience API (xAPI), a standard for recording individual or group activities across various technologies, is utilized to capture student activities through metadata in e-learning environments. Subsequently, clustering and prediction methods are applied to analyze e-learning features based on a predefined student profile model. Most Learning Management Systems (LMS), or e-learning applications, are integrated with web page collaboration, allowing direct communication between users and multiple web-based applications. However, a comprehensive analysis of user behavior has been lacking. Given the online nature of the instructional medium, it is crucial to analyze each student's blended learning behavior so that instructors can adapt online activities accordingly.

Talianskaia and Babushkin (2020) concluded that trends in modern education are moving towards further 'colonization' of the education process and related changes in the interaction between students and educational institutions. To build a firmer connection with students, the explicit image of the student is required, and specific features are defined by analyzing data from students' profile pages with insights based on it.

Hunapi et al. (2019) proposed that profiling students' environmental attitudes can be effectively conducted using the Sasak Tribe local wisdom-integrated (LWI) model., can provide valuable insights to educators. This Information can help teachers create innovative and practical approaches to teaching about the environment, an area where current methods still need to be improved. The LWI learning implementation can also introduce Indonesian local wisdom to a broader audience, particularly in the education sector, while utilizing local resources optimally.

### **2.4 Technology Acceptance Model**

According to Yudiantara et al. (2018), The most popular and prominent model for explaining why people accept and use information technologies is called Technology Acceptance Model, or TAM. When it comes to forecasting and explaining consumer behavior about their adoption of new technology, the TAM model is a very reliable tool. The Technology Acceptance Model (TAM) is a theory used to understand technology acceptance. It is based on the Theory of Reasoned Action (TRA) was the foundation for Fred D. Davis' 1986 introduction of the Theory of Acceptance and Motivation (TAM), which attempted to explain the actions of information systems users. Furthermore, Ismail et al. (2019) noted that TAM is one of the most important models used to describe behavior in information technology

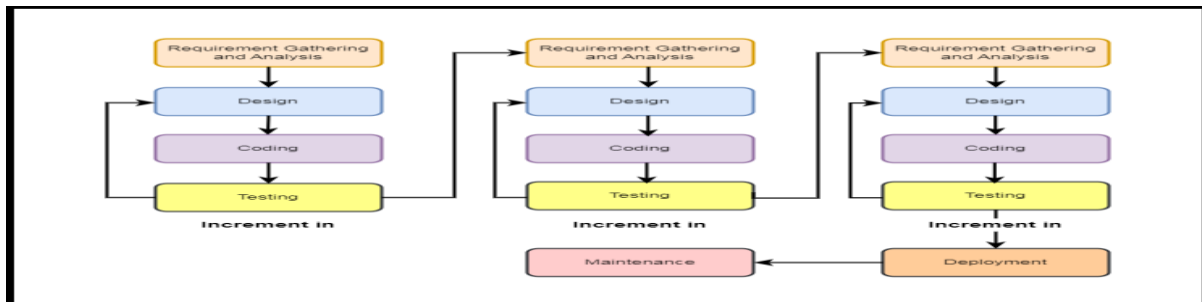
consumption because of its understandability. According to TAM, a person's attitude toward utilizing technology directly affects how they actually utilize it.

### III. METHODOLOGY

To support the planning and development of the proposed system, the researcher utilized the following techniques and protocols:

#### 3.1 Research Design

For the development of the Grantees Information System in this project, we have selected the Agile methodology as our System Development Life Cycle (SDLC) approach.



**Figure 3. Agile Model**

The proposed system was developed using the Agile Model, shown in Figure 3. Also, Agile is comprised of six distinct phases. These are:

#### Phase 1: Gathering and analyzing requirements

During this phase, the project researchers collaborate with stakeholders to identify and document the software requirements. They review these criteria to ensure they are comprehensive, accurate, and achievable.

#### Phase 2: Design

In this phase, the researchers develop a comprehensive software design derived from the requirements. This design encompasses the software architecture, data structures, user interface, and various other technical specifications.

#### Phase 3: Coding

During this phase, the researchers start coding the software based on the design specifications. They adhere to coding standards and best practices to ensure that the code is efficient, maintainable, and scalable.

#### Phase 4: Testing

In this phase, the researchers test the software to detect and correct any bugs or errors. They perform a range of testing types, including unit testing, integration testing, system testing, and acceptance testing.

#### Phase 5: Deployment

In the deployment phase, the researchers release the information system into the production environment, making it accessible to end-users. They gather feedback

from users to refine and enhance the system in future updates.

#### Phase 6: Maintenance

During the maintenance phase, the researchers offer continuous support and upkeep for the software. This involves addressing bugs, performing updates, and adding new features as necessary.

#### 3.2 Physical Environment and Resources

This section outlines the hardware, software, personnel, and network requirements needed for the development of the system.

##### Hardware

The following hardware is required for the system's implementation:

- Laptop/Computer: Essential for running operations, creating, and testing the system. It also facilitates data storage and processing.

##### Software

The following software is necessary for implementing the system:

- Visual Studio Code: A modern code editor tailored for developing and debugging online and cloud applications.
- Laravel: A user-friendly web framework for building scalable PHP-based websites and applications.
- XAMPP: An open-source, cross-platform web server solution stack provided by Apache Friends, including MariaDB, Apache HTTP Server, and PHP/Perl

interpreters.

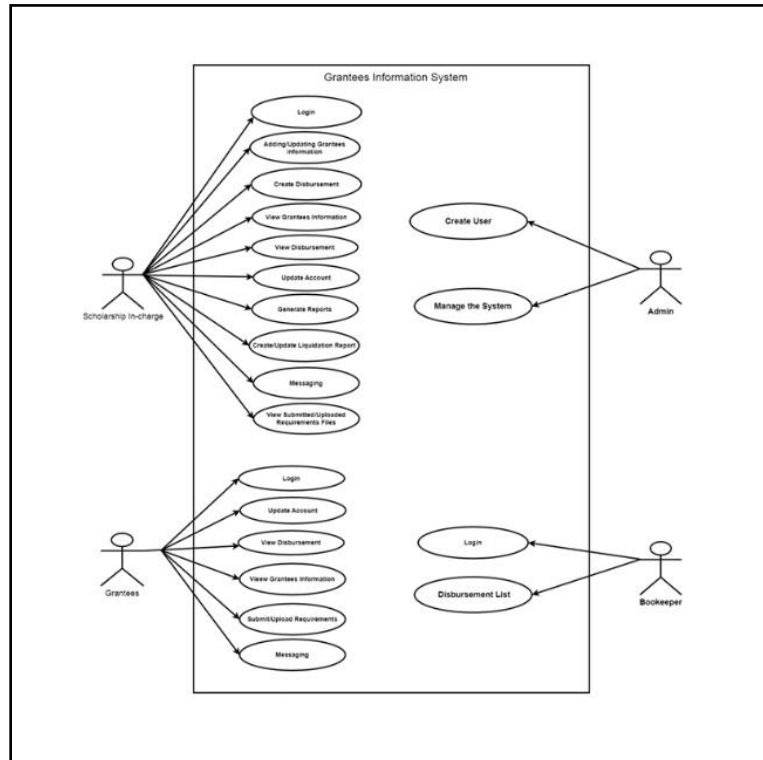
- AdminLTE: A popular open-source template for web application dashboards and admin control panels, built on the Bootstrap 3 framework and designed to be responsive.
- PHP: A widely-used server-side scripting language for web development.
- MySQL: A relational database management system (RDBMS) developed by Oracle, utilizing structured query language (SQL).

### 3.3 Tools and Techniques for the Study

This study examines various types of software diagrams, including use case diagrams, context diagrams, data flow diagrams, and entity-relationship diagrams.

#### Use Case Diagram

A use case diagram depicts the interactions between use cases and actors. It details the functions or operations performed within the module, with actors representing either the end-users of the system or external systems that interact with it.



**Figure 4.** Use Case Diagram

As shown in Figure 4, a use case demonstrates how a user accomplishes a particular goal within a process or system. In this case, users log in to access the system's features. Once logged in, they are able to use the functionalities provided by the system.

#### Initial Step-by-Step Description:

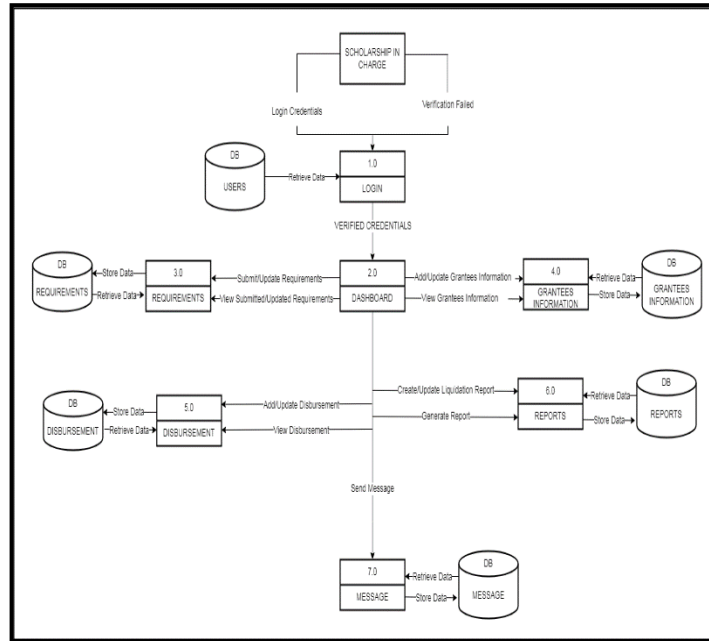
Before initiating this use case, the user must be connected to the Grantees Information System.

1. The user inputs their email and password, then clicks the sign-in button.

2. Depending on their user role, the user gains access to various features of the system. After using the system, they can log out.

#### Context Diagram

A context diagram illustrates the interaction between external entities and an internal software system. This diagram provides a high-level overview of the entire system, presenting it in a straightforward and easily comprehensible manner.

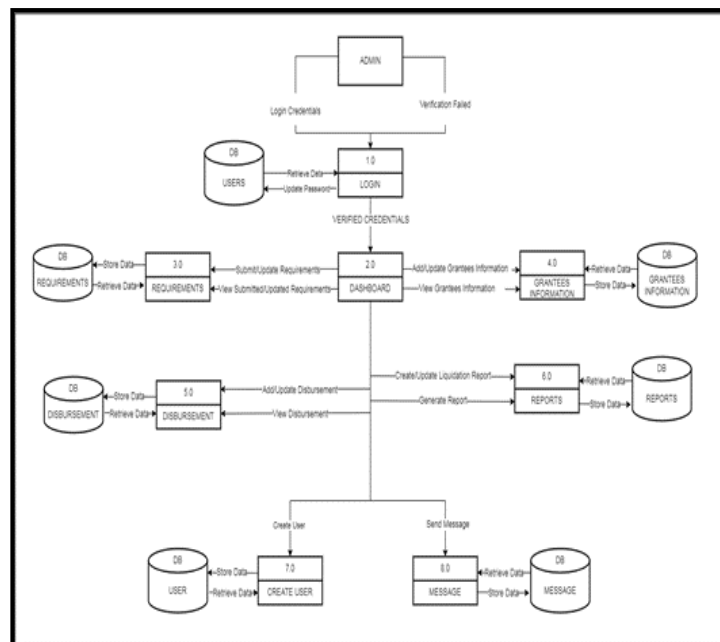


**Figure 5. Context Diagram**

**Data Flow Diagram**

A data flow diagram (DFD) visually depicts how data moves through a system or process. DFDs are valuable for

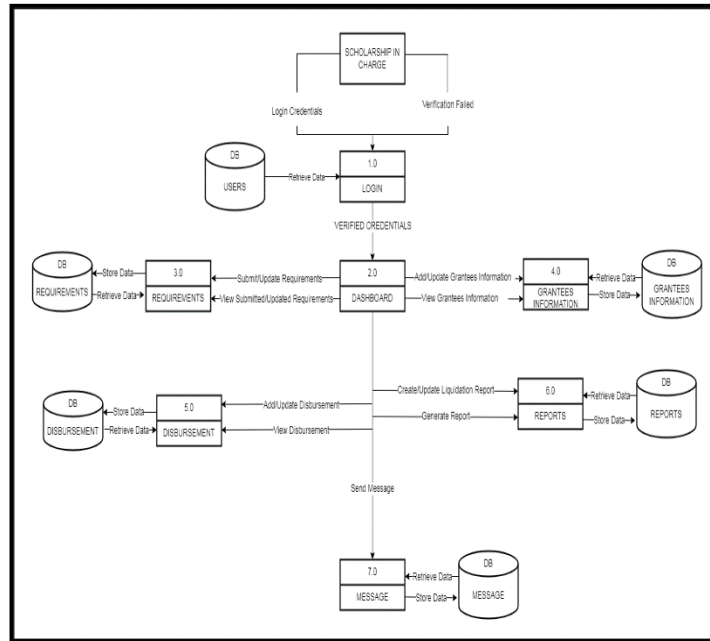
improving understanding of system operations, which can enhance overall efficiency. They also help in identifying potential problems and developing better practices.



**Figure 6. Admin Data Flow Diagram**

The diagram shows how administrative data flows through the system. Initially, the admin logs in with the appropriate credentials. Once logged in, they are taken to the dashboard,

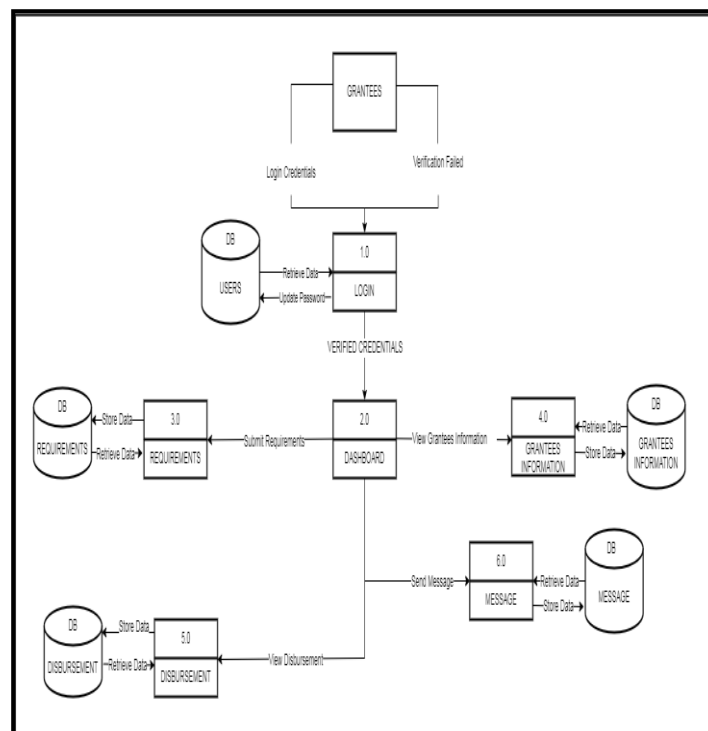
where they can create users and assign roles. While the admin supervises system control, the Scholarship component handles the data management.



**Figure 7. Scholarship In Charge Data Flow Diagram**

The diagram demonstrates the interaction of the Scholarship in charge with the system. Initially, the Scholarship in charge logs in using the correct credentials. Upon successful login, they are directed to the dashboard. From there, the

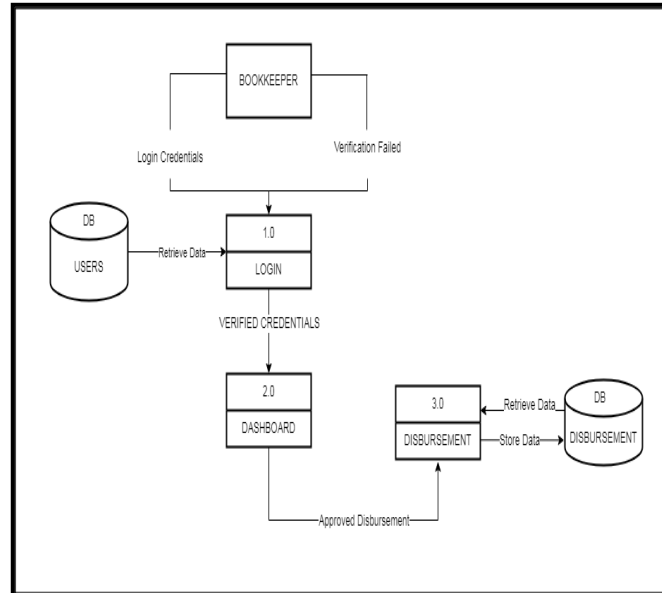
Scholarship in charge can perform various actions such as adding grantees, inputting their details, generating reports, reviewing graduation grantee requirements, creating disbursements, and sending messages to grantees.



**Figure 8. Grantees Data Flow Diagram**

The diagram depicts how grantees interact with the system. Initially, grantees log in using credentials provided by the scholarship in charge. Upon logging in, they are directed to a dashboard with specific functionalities. Grantees can view

their information and disbursement details, submit requirements, and use messaging to communicate with the scholarship in charge.

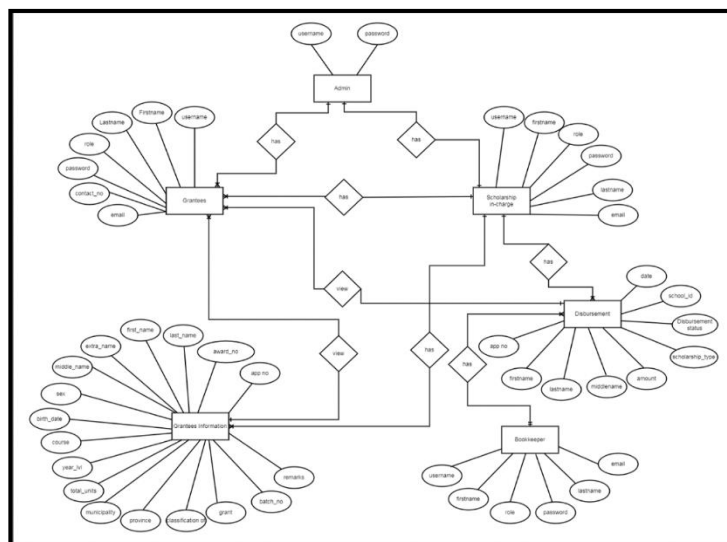


**Figure 9.** Bookkeeper Data Flow Diagram

The diagram depicts the data flow for bookkeepers. Initially, the bookkeeper logs in using credentials provided by the admin. After a successful login, they are directed to the dashboard, where they can approve disbursements for grantees once they have been released.

**Entity-Relationship Diagram**

An entity-relationship diagram (ERD) is a data modeling tool that visually represents entities and their relationships within an information system. It offers a conceptual and symbolic representation of the data structure, outlining the framework of the entity architecture.



**Figure 10.** Entity Relationship Diagram

The ERD is a crucial component of this capstone project, providing a clear depiction of our database structure. It details the entities, attributes, and their interrelationships, serving as the foundation of our application. We have prioritized data accuracy, efficient relationships, and adherence to normalization principles. The ERD acts as a dynamic reference, guiding the project and adapting to our evolving requirements.

### 3.4. Participants and Sampling Procedure

Data for this study was collected from the scholarship administrator at our institution, selected as the primary informant due to her direct involvement and extensive experience in managing the scholarship program. The study focuses on 15 students who are recipients of the TDP, FESPA, and TES scholarships at St. Peter's College,

encompassing all year levels and courses associated with these scholarships. Data was obtained through official channels from the scholarship administrator, ensuring thorough and accurate access to the necessary information for the study.

## IV. RESULTS AND DISCUSSION

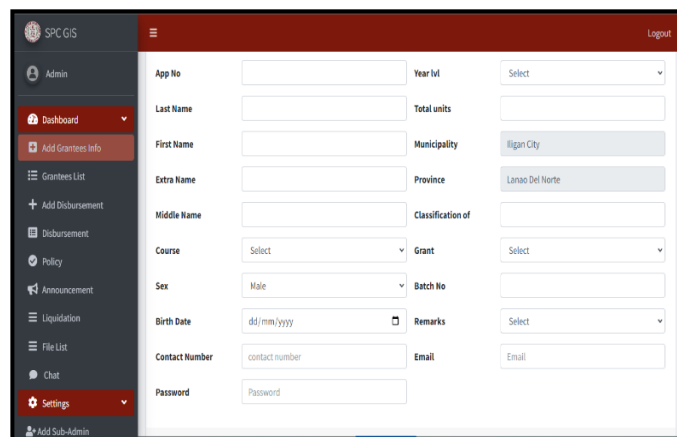
This section presents the implementation of the project, outlines the study's findings, and provides a brief discussion on the system's evaluation. It also includes an overview of the system's interface and an analysis of the data collected from the questionnaires distributed to the respondents.

### 4.1 Final Product

This is the complete presentation of the system.



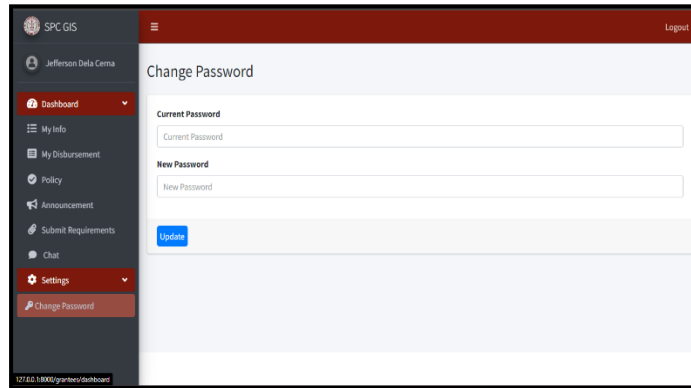
**Figure 11.** Login Form



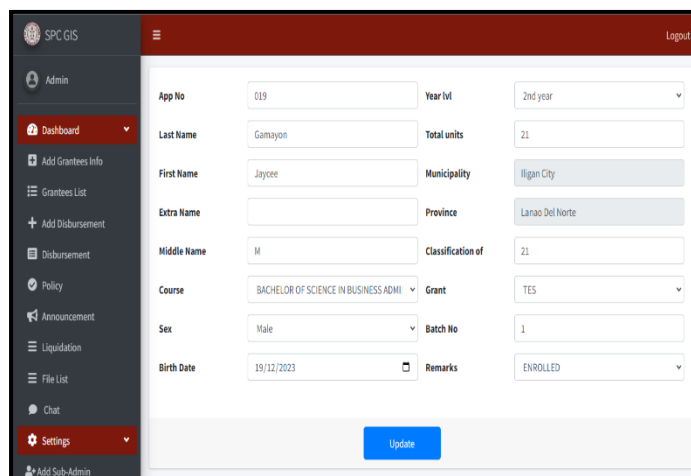
**Figure 12.** Create User Form

In Figure 11, users interact with the login form of the website. Meanwhile, in Figure 12, the scholarship in charge utilizes a dedicated form to create a grantee user, inputting

relevant information into the system. This process ensures systematic management of grantees' details within the system.



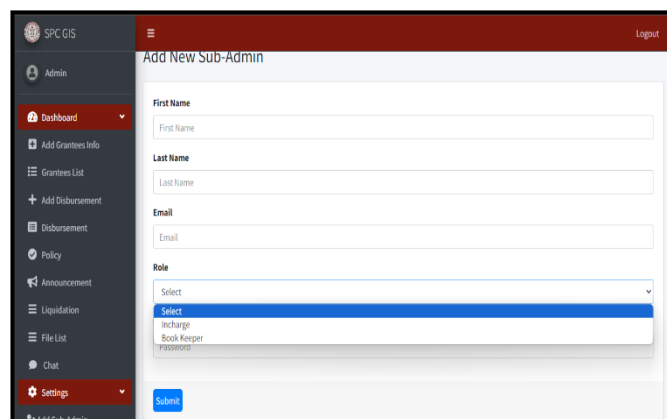
**Figure 13.** Update Password Form



**Figure 14.** Update Grantees Information

In Figure 13, users encounter the updated password form, enabling grantees to change their passwords securely. Conversely, Figure 14 presents the form dedicated to

updating grantees' information, offering a comprehensive platform for managing and modifying their details within the system



**Figure 15.** Setting user/role rights



SEQ	APP NO	LASTNAME	FIRSTNAME	EXTNAME	MIDDLENAME	SEX	BIRTHDATE	COURSE/PROGRAM ENROLLED	YEAR LEVEL	TOTAL UNITS
1	019	Gamayon	Jaycee		M	Male	2023-12-19	BSBA	2nd	21
2	013	Liver	Bernadine		Sprigin	Male	2023-12-11	BSME	1st	15
3	012	Twigge	Moyra		Bullar	Male	2023-12-11	AB-POLSCI	2nd	1
4	011	Tyndall	Dill		Neller	Male	2023-12-17	AB-FIL	2nd	21
5	010	Greggs	Tabbi		Drennan	Male	2023-06-21	AB-ENG	2nd	23
6	009	Ruffell	Alayn		Dumbell	Male	2024-01-14	BSED	2nd	1
7	008	Farthing	Susi		Androck	Male	2023-12-20	AB-FIL	2nd	21
8	007	Hewerton	Nolana		Pardal	Male	2023-12-13	AB-ENG	2nd	21

**Figure 16. Status of Scholarship**

YEAR LEVEL	TOTAL UNITS	MUNICIPALITY	PROVINCE	CLASSIFICATION	GRANT	BATCH NO	REMARKS	Action
2nd	21	Iligan City	Lanao Del Norte	21	TES	1	ENROLLED	Edit Delete
1st	15	Iligan City	Lanao Del Norte		UNIFAST	1	ENROLLED	Edit Delete
2nd	1	Iligan City	Lanao Del Norte	1	TES	21	ENROLLED	Edit Delete
2nd	21	Iligan City	Lanao Del Norte		TDP	1	ENROLLED	Edit Delete
2nd	23	Iligan City	Lanao Del Norte	1	TDP	1	ENROLLED	Edit Delete
2nd	1	Iligan City	Lanao Del Norte	1	TDP	1	ENROLLED	Edit Delete
2nd	21	Iligan City	Lanao Del Norte		UNIFAST	21	NOT ENROLLED	Edit Delete
2nd	21	Iligan City	Lanao Del Norte		STUFAPS	1	ENROLLED	Edit Delete

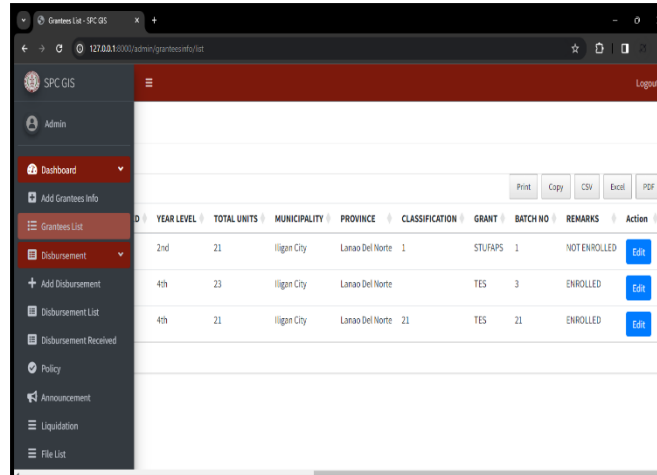
**Figure 17. Status of Scholarship**

In Figure 15, administrators define user roles and rights, establishing the framework for created user permissions. Meanwhile, Figures 16 and 17 house the data about grantees, providing a platform for them to access and view

the current status of their scholarships. This segmentation ensures a structured approach to user management and grantee information within the system.

APP NO	LASTNAME	FIRSTNAME	EXTNAME	MIDDLENAME	SEX	BIRTHDATE	COURSE/PROGRAM ENROLLED	YEAR LEVEL	TOTAL UNITS	MUNICIPALITY	PROVINCE	CLASSIFICATION	GRADE	
1	019	Gamayon	Jaycee		M	Male	2023-12-19	BSBA	2nd	21	Iligan City	Lanao Del Norte	21	TES
2	013	Liver	Bernadine		Sprigin	Male	2023-12-11	BSME	1st	15	Iligan City	Lanao Del Norte		UNIF
3	012	Twigge	Moyra		Bullar	Male	2023-12-11	AB-POLSCI	2nd	1	Iligan City	Lanao Del Norte	1	TES
4	011	Tyndall	Dill		Neller	Male	2023-12-17	AB-FIL	2nd	21	Iligan City	Lanao Del Norte		TDP
5	010	Greggs	Tabbi		Drennan	Male	2023-06-21	AB-ENG	2nd	23	Iligan City	Lanao Del Norte	1	TDP
6	009	Ruffell	Alayn		Dumbell	Male	2024-01-14	BSED	2nd	1	Iligan City	Lanao Del Norte	1	TDP
7	008	Farthing	Susi		Androck	Male	2023-12-20	AB-FIL	2nd	21	Iligan City	Lanao Del Norte		UNIF
8	007	Hewerton	Nolana		Pardal	Male	2023-12-13	AB-ENG	2nd	21	Iligan City	Lanao Del Norte		STUF
9	005	Simmell	Caspar		Hallyard	Male	2023-12-17	BSED	2nd	21	Iligan City	Lanao Del Norte		TDP

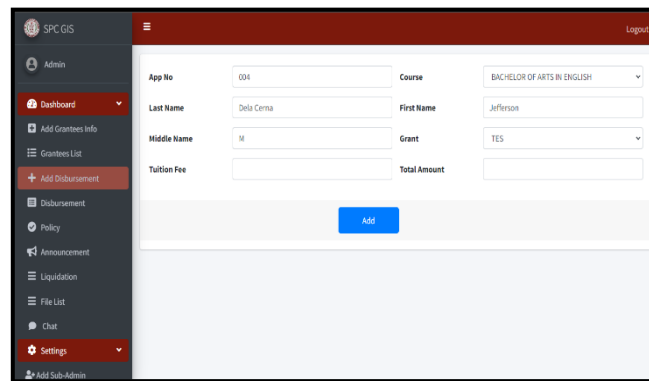
**Figure 18. Generate Report Form**



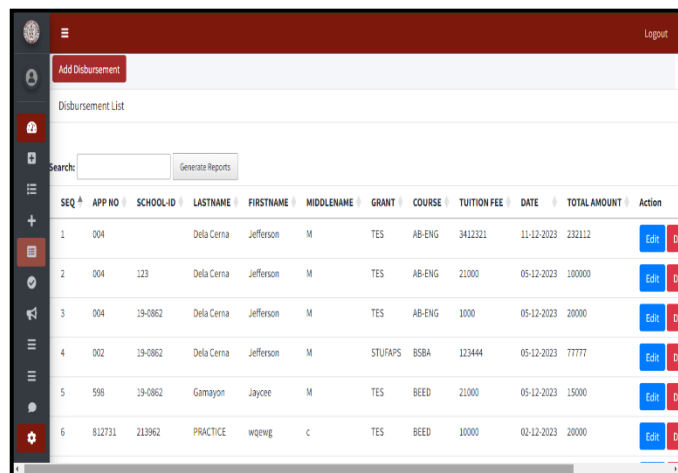
**Figure 19.** Generate Report Form

Figures 18 and 19 encapsulate vital data, empowering the scholarship in charge to generate comprehensive reports. A seamless process is initiated upon clicking the 'Generate' button, offering versatile options such as printing, copying the clipboard, and exporting to CSV, Excel, and PDF

formats. This feature streamlines the reporting process, significantly enhancing the efficiency of scholarship management by providing multiple avenues for analysis and documentation.



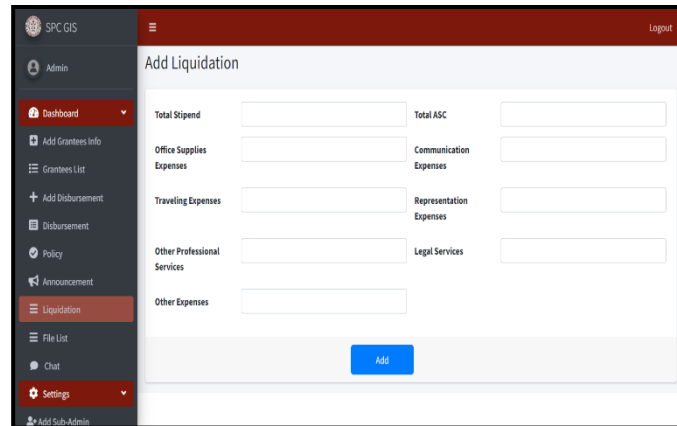
**Figure 20.** Create/Update Disbursement



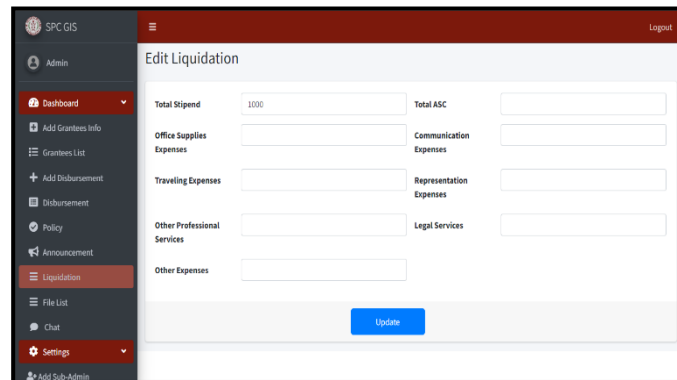
**Figure 21.** Create/Update Disbursement

In Figure 20, users encounter the Create Disbursement Page, while Figure 21 illustrates the page after activating the 'Add' button. Facilitating updates, users can seamlessly click the

'Edit' button, redirecting to Figure 19 for efficient disbursement modification. This cyclical process ensures a user-friendly experience in managing disbursement details.

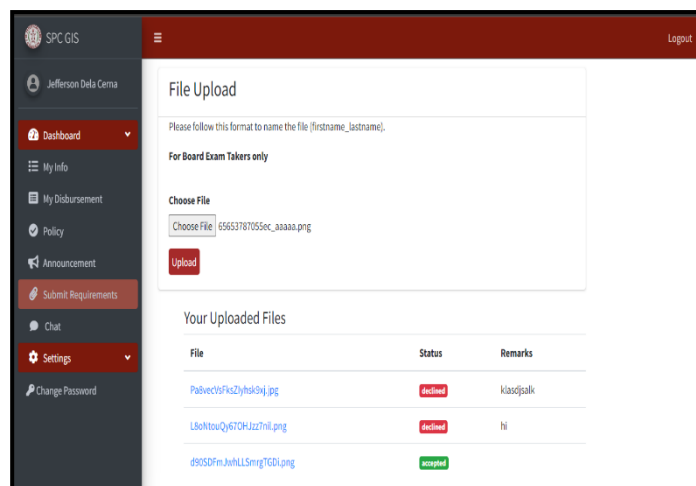


**Figure 22. Create Liquidation**



**Figure 23. Update Liquidation**

In Figure 22, the scholarship in charge utilizes a form to add liquidation details. Meanwhile, Figure 23 features a dedicated form for updating the liquidation information, providing a comprehensive platform for managing financial records efficiently.

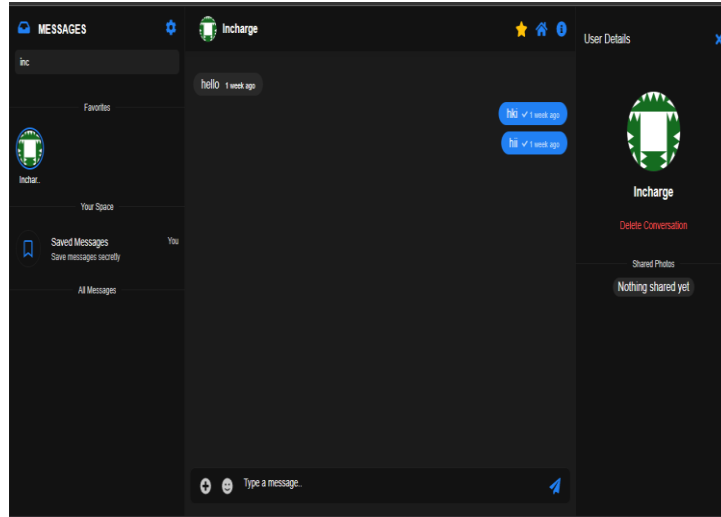


File	Status	Remarks
Pabveetvi7k2j/hsk9nj.jpg	declined	Kiasqpsalk
L8oNtouQy6T0HJzz7ml.png	declined	hi
49QSDFn.JuNLLSmrgTGDl.png	accepted	

**Figure 24. Submit/Upload Requirements**

Figure 24 is a pivotal point where graduating grantees can submit their requisite documents for the board passing degree. This crucial step ensures compliance with necessary academic qualifications and is the gateway for processing refunds. The meticulous submission of these documents in

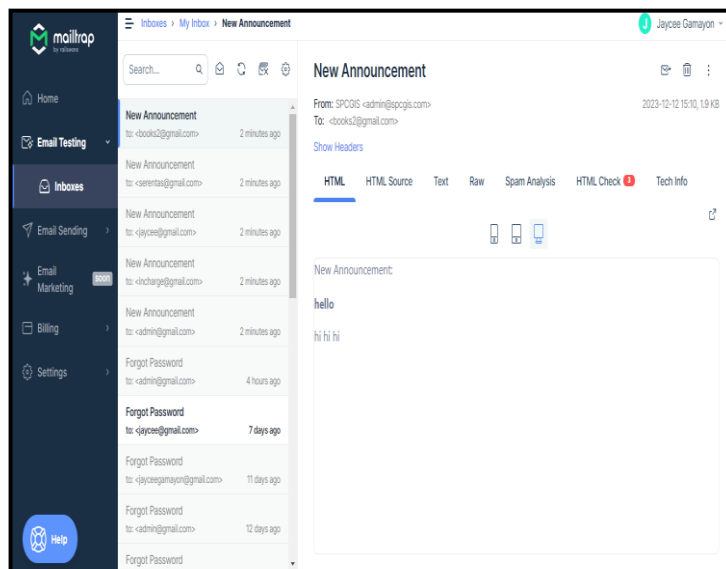
Figure 22 initiates a streamlined procedure, allowing for the efficient verification of qualifications and subsequent processing of financial refunds to eligible grantees who have successfully met the board's requirements



**Figure 25.** Messaging

In Figure 25, a dedicated messaging platform facilitates seamless communication between the grantees and the scholarship in charge. This interactive feature allows for efficient and direct dialogue, enabling grantees to seek guidance, address concerns, and share updates with the

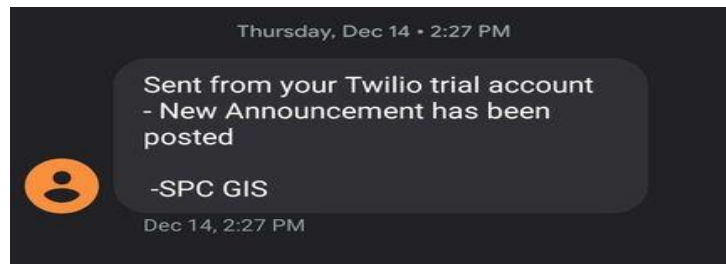
scholarship administration. The platform is a vital communication channel, fostering a transparent and collaborative environment to enhance the scholarship experience.



**Figure 26.** Email Notification

In Figure 26, an email notification system is depicted. This system is designed to alert grantees whenever a new

announcement is posted by the Scholarship in Charge, ensuring timely communication through email.



**Figure 27.** SMS Notification

In Figure 27, an SMS notification system is illustrated. This system is crafted to promptly notify grantees whenever the Scholarship in Charge publishes a new announcement. The implementation ensures swift communication via SMS, leveraging Twilio for seamless and efficient delivery of notifications.

**Objective 2: Evaluate the Grantee's Information System's acceptance level and its efficacy using the Technology Acceptance Model by the grantee's students**

**Table 1:** Course of the Grantees Students

The table below presents data on the number and percentage of respondents from various courses. The frequency column shows the count of respondents for each course, while the percentage column reflects their proportion relative to the total number of participants. Both COE and CRIM had 37 respondents each, representing 18.9% of the total. CCS and CBA each had 6 respondents, making up 16.2% of the total. CASS had 5 respondents, accounting for 13.5%, and CED had 4 respondents, representing 10.8% of the total.

Course	Frequency	Percent
CCS	6	16.2
COE	8	21.6
CRIM	8	21.6
CBA	6	16.2
CASS	5	13.5
CED	4	10.9
<b>Total</b>	<b>37</b>	<b>100</b>

**Table 2.** Year Level

The table below illustrates the distribution of respondents across various year levels. The frequency column shows the number of respondents in each year level, while the percentage column indicates the proportion of each year level relative to the total number of respondents.

Specifically, there are 2 respondents in the first year, representing 5.4% of the total. The second year has 3 respondents, making up 8.1%. The third year comprises 12 respondents, accounting for 32.4%. Finally, there are 20 respondents in the fourth year, which constitutes 54.1% of the total.

Year level	Frequency	Percent
First Years	2	5.4
Second Years	3	8.1
Third Years	12	32.4
Fourth Years	20	54.1
<b>Total</b>	<b>37</b>	<b>100</b>

**Table 3.** Age

The table below presents students categorized by age groups. It reveals that among the grantees, there are 19 individuals below the age of 19, with a specific focus on

those aged 2, constituting 5.4% of the total grantees. Additionally, there is one grantee aged 26 or above. Lastly, 35 grantees represent 94.5% of the total participants.



Age	Frequency	Percent
19-below	1	2.7
20-25	35	94.5
26-above	1	2.7
<b>Total</b>	<b>37</b>	<b>100</b>

**Perceived Ease of Use**

The table provides an overview of grantees' perceptions regarding the ease of use of the Grantees Information System. The "Mean" column displays the average ratings given by respondents, reflecting their views on the system's usability. Overall, respondents consider the system to be

intuitive, easy to understand, and effective in enhancing their performance. The "Verbal Description" column offers a qualitative summary of the mean scores, representing the respondents' positive evaluations of the system's usability and functionality. These evaluations range from "Strongly Disagree" to "Strongly Agree."

Item	Frequency	Interpretation
I perceive the Grantees Information System as easy to use	4.81	Strongly Agree
I find learning how to use the Grantees Information System easy	4.78	Strongly Agree
Mastering the use of the Grantees Information System is straightforward for me.	4.76	Strongly Agree
I find my interaction with the Grantees Information System to be clear and understandable.	4.78	Strongly Agree
Overall, I find the Grantees Information System easy to use	4.81	Strongly Agree
<b>Over-all Mean:</b>	<b>4.98</b>	<b>Strongly Agree</b>

**Table 4.** Perceived Ease of Use

Legend:

Scale	Interval	Description	Interpretation
5	4.20-5.00	Highly Positive	Strongly Agree
4	3.40-4.19	Positive	Agree
3	2.60-3.39	Neutral	Neutral
2	1.80-.259	Negative	Disagree
1	1.00-1.79	Highly Negative	Strongly Disagree

**Perceived Usefulness**

The table below demonstrates that respondents broadly agree that the Grantees Information System boosts their

productivity. They perceive it as a valuable asset for enhancing efficiency, anticipating that it will speed up task completion and support more efficient job performance.

**Table 5.** Perceived Usefulness

Item	Frequency	Interpretation
Accessing the Grantees Information System makes it easier for me to find and use relevant scholarship information.	4.84	Strongly Agree



Grantees Information System provides me with valuable scholarship-related information	4.84	Strongly Agree
Using the Grantees Information System makes it easier to see my scholarship information	4.84	Strongly Agree
Using the Grantees Information System gives me greater control over my scholarship information	4.81	Strongly Agree
Overall, the Grantees Information System is helpful as a Grantee	4.86	Strongly Agree
<b>Over-all Mean:</b>	<b>4.838</b>	<b>Strongly Agree</b>

Legend:

Scale	Interval	Description	Interpretation
5	4.20-5.00	Highly Positive	Strongly Agree
4	3.40-4.19	Positive	Agree
3	2.60-3.39	Neutral	Neutral
2	1.80-.259	Negative	Disagree
1	1.00-1.79	Highly Negative	Strongly Disagree

**Attitude toward Usage**

The table below displays respondents' agreement on the perceived advantages of using the Grantees Information

System for their needs. They indicate a strong intention to use the system for various tasks, work-related activities, and any pertinent issues that may arise.

**Table 6. Attitude Toward Usage**

Item	Frequency	Interpretation
I am optimistic about using the Grantees Information System to access scholarship-related information.	4.84	Strongly Agree
Using the Grantees Information System aligns with my goals for managing scholarship information effectively.	4.87	Strongly Agree
I view the Grantees Information System as a valuable tool for accessing scholarship information	4.81	Strongly Agree
Utilizing the Grantees Information System to access scholarship information is a positive step.	4.76	Strongly Agree
I am enthusiastic about using the Grantees Information System to manage scholarship-related data.	4.84	Strongly Agree



<b>Over-all Mean:</b>	<b>4.01666667</b>	<b>Strongly Agree</b>
-----------------------	-------------------	-----------------------

Legend

Scale	Interval	Description	Interpretation
5	4.20-5.00	Highly Positive	Strongly Agree
4	3.40-4.19	Positive	Agree
3	2.60-3.39	Neutral	Neutral
2	1.80-.259	Negative	Disagree
1	1.00-1.79	Highly Negative	Strongly Disagree

**V. CONCLUSION**

Based on the findings of the study, the following conclusions can be stated: The GIS at St. Peter's College, Iligan City, has indeed improved efficiency in scholarship management and has made a system truly transparent. Such a grantee-oriented system successfully deals with problems that have beset the Scholarship in Charge by improving the communication line and by easing the process of informing grantees about their scholarship status and about the date of fund disbursement. The identified GIS solves many of the problems inherent in manual systems and adds to the overall objective of better management of scholarships within institutions of higher learning. This effort, therefore, targets bringing into place a more managed and efficient approach, integrating appropriate technologies.

**Ethical Approval**

In December 2023, the researchers obtained approval from both the Office of Research and the Dean of Computer Studies. Additionally, they received authorization from the President of St. Peter's College, Iligan City, to carry out surveys with students from the College of Computer Studies. Each participant gave written consent, acknowledging the potential dissemination of their data while ensuring that privacy was maintained.

**Data Availability**

**Underlying data**

Figshare: Grantees Information System  
<https://doi.org/10.6084/m9.figshare.26197952.v4>

The project contains extended data.  
 - QuestionnaireGIS.docx

**VI. REFERENCES**

- [1]. Alvaro, P. A. R., & Gabayan Jr., V. P. (2021). Scholarship information management system with academic performance predictor and decision support system. *\*The Journal of Technology and Christianity\**.
- [2]. Anamisa, D. R., Rachmad, A., Putro, S. S., Jauhari, A., Khozaimi, A., Pujiastutik, R., & Rahmanita, E. (2018). The selection system of student scholarship based on simple additive weighting and technique for order preference by similarity to ideal solution method. *\*EU Digital Library\**.
- [3]. Forrester, V. V. (2019). School management information systems: Challenges to educational decision-making in the big data era. *\*arXiv\**.
- [4]. Hunaepi, H., Dewi, I. N., & Sumarjan, S. (2019). Profiling students' environmental care attitudes taught using Sasak Tribe, the local wisdom-integrated model. *\*ERIC\**.
- [5]. Ibrahim, (2021). Scholarship monitoring information system at Ar-Raniry Islamic University. *\*Semantic Scholar\**.
- [6]. Komsari, A., & Airlangga, P. (2021). Website-based design of scholarship information distribution system for UNWAHA students. *\*Newton: Jurnal Perubatan & Kesehatan\**.
- [7]. Pramono, B., Purnomo, A. C., & Oganda, F. P. (2019). Design of information system in admission of new students based on web in SMK Al Amanah. *\*International Journal of Computing\**.
- [8]. Sa'diah, H., Sulaiman, A., & Rizali, A. M. (2021). Management of academic information system in higher education. *\*Semantic Scholar\**.
- [9]. Talianskaia, M., & Babushkin, S. (2020). Student profiling in online social networks.

# IJEAST

INTERNATIONAL JOURNAL  
OF ENGINEERING APPLIED SCIENCE  
AND TECHNOLOGY

## ABOUT IJEAST

International Journal of Engineering Applied Science and Technology (IJEAST) is a peer-reviewed, open access journal that publishes high-quality research papers in the field of Engineering, Applied Science and Technology.

IJEAST aims to provide a platform for researchers, academicians, and professionals to share their innovative ideas, research findings, and practical experiences with the global scientific community.

## FOCUS AREAS

- Engineering
- Applied Science
- Technology
- Innovation & Development
- Interdisciplinary Studies



### PEER REVIEWED

All submissions are rigorously peer reviewed to ensure quality.



### OPEN ACCESS

Free and unrestricted access to research for all.



### GLOBAL REACH

Connecting researchers and professionals worldwide.



### TIMELY PUBLICATION

We ensure a swift and efficient publication process.



For more information, visit our website

[www.ijeast.com](http://www.ijeast.com)



INTERNATIONAL JOURNAL  
OF ENGINEERING APPLIED SCIENCE  
AND TECHNOLOGY

✉ [editor@ijeast.com](mailto:editor@ijeast.com)

🌐 [www.ijeast.com](http://www.ijeast.com)

📍 India



2455-2143